



STB-2000

HD Commercial Interface Set-top Box

Commercial Mode Setup Guide

Interactive Pro:Centric® •
Functionality
RF or IP Content Delivery •

EXPERIENCED INSTALLER

EZ-Manager Wizard
pages 15–22

Custom Master STB Setup
pages 35–38

FTG Mode of Operation
pages 45–51

For Customer Support/Service, please call:

1-888-865-3026

The latest product information and documentation is available online at:

www.LG solutions.com

MODEL and SERIAL NUMBER

The model and serial numbers of this STB are located on the back of the cabinet. For future reference, LG suggests that you record those numbers here:

Model No. _____ Serial No. _____



WARNING:

TO REDUCE THE RISK OF ELECTRIC SHOCK DO NOT REMOVE COVER (OR BACK). NO USER-SERVICEABLE PARTS INSIDE. REFER TO QUALIFIED SERVICE PERSONNEL.



The lightning flash with arrowhead symbol, within an equilateral triangle, is intended to alert the user to the presence of uninsulated "dangerous voltage" within the product's enclosure that may be of sufficient magnitude to constitute a risk of electric shock to persons.



The exclamation point within an equilateral triangle is intended to alert the user to the presence of important operating and maintenance (servicing) instructions in the literature accompanying the appliance.

WARNING:

TO PREVENT FIRE OR SHOCK HAZARDS, DO NOT EXPOSE THIS PRODUCT TO RAIN OR MOISTURE.

NOTE TO CABLE/TV INSTALLER:

This reminder is provided to call the cable TV system installer's attention to Article 820-40 of the National Electrical Code (U.S.A.). The code provides guidelines for proper grounding and, in particular, specifies that the cable ground shall be connected to the grounding system of the building, as close to the point of the cable entry as practical.

REGULATORY INFORMATION:

This equipment has been tested and found to comply with the limits for a Class B digital device, pursuant to Part 15 of the FCC Rules. These limits are designed to provide reasonable protection against harmful interference when the equipment is operated in a residential installation. This equipment generates, uses and can radiate radio frequency energy and, if not installed and used in accordance with the instruction manual, may cause harmful interference to radio communications. However, there is no guarantee that interference will not occur in a particular installation. If this equipment does cause harmful interference to radio or television reception, which can be determined by turning the equipment off and on, the user is encouraged to try to correct the interference by one or more of the following measures:

- Reorient or relocate the receiving antenna.
- Increase the separation between the equipment and receiver.
- Connect the equipment to an outlet on a circuit different from that to which the receiver is connected.
- Consult the dealer or an experienced radio/TV technician for help.

CAUTION:

Do not attempt to modify this product in any way without written authorization from LG Electronics U.S.A., Inc. Unauthorized modification could void the user's authority to operate this product.

COMPLIANCE:

The responsible party for this product's compliance is: LG Electronics U.S.A., Inc.
1000 Sylvan Avenue, Englewood Cliffs, NJ 07632, USA • Phone: 1-201-816-2000

Marketed and Distributed in the United States by LG Electronics U.S.A., Inc.
1000 Sylvan Avenue, Englewood Cliffs, NJ 07632

IMPORTANT SAFETY INSTRUCTIONS

1. Read these instructions.
2. Keep these instructions.
3. Heed all warnings.
4. Follow all instructions.
5. Do not use this apparatus near water.
6. Clean only with dry cloth.
7. Do not block any ventilation openings. Install in accordance with the manufacturer's instructions.
8. Do not install near any heat sources, such as radiators, heat registers, stoves, or other apparatus (including amplifiers) that produce heat.
9. Do not defeat the safety purpose of the polarized or grounding-type plug. A polarized plug has two blades with one wider than the other. A grounding-type plug has two blades and a third grounding prong. The wide blade or the third prong are provided for your safety. If the provided plug does not fit into your outlet, consult an electrician for replacement of the obsolete outlet.
10. Protect the power cord from being walked on or pinched, particularly at plugs, convenience receptacles, and the point where it exits from the apparatus.
11. Only use attachments/accessories specified by the manufacturer.
12. Use only with the cart, stand, tripod, bracket, or table specified by the manufacturer or sold with the apparatus. When a cart is used, use caution when moving the cart/apparatus combination in order to avoid injury from tip-over.



13. Refer all servicing to qualified service personnel. Servicing is required when the apparatus has been damaged in any way, such as power-supply cord or plug is damaged, liquid has been spilled or objects have fallen into the apparatus, the apparatus has been exposed to rain or moisture, does not operate normally, or has been dropped.
14. Never touch this apparatus or antenna during a thunder or lightning storm.
15. When mounting an STB on the wall, make sure not to install the STB by the hanging power and signal cables on the back of the STB.
16. Do not allow an impact shock or any objects to fall into the product.

17. Power Cord

Caution: It is recommended that appliances be placed upon a dedicated circuit; that is, a single outlet circuit which powers only that appliance and has no additional outlets or branch circuits. Check the STB specifications.

Periodically examine the cord of your appliance, and if its appearance indicates damage or deterioration, unplug it, discontinue use of the appliance, and have the cord replaced with an exact replacement part by an authorized servicer. Protect the power cord from physical or mechanical abuse, such as twisting, kinking, or pinching or being closed in a door or walked upon. Pay particular attention to plugs, wall outlets, and the point where the cord exits the appliance.

Do not use a damaged or loose power cord. Be sure to grasp the plug when unplugging the power cord. Do not pull on the power cord to unplug the STB.

18. Overloading

Do not connect too many appliances to the same AC power outlet as this could result in fire or electric shock. Do not overload wall outlets. Overloaded wall outlets, loose or damaged wall outlets, extension cords, frayed power cords, or damaged or cracked wire insulation are dangerous. Any of these conditions could result in fire or electric shock.

19. Outdoor Use/Wet Location



Warning: To reduce the risk of fire or electrical shock, do not expose this product to rain, moisture or other liquids.

Do not touch the STB with wet hands. Do not install this product near flammable objects such as gasoline or candles or expose the STB to direct air conditioning.

Do not expose to dripping or splashing and do not place objects filled with liquids, such as vases, cups, etc., on or over the apparatus (e.g., on shelves above the unit).

20. Grounding

Ensure that you connect the earth ground wire to prevent possible electric shock (i.e., an STB with a three-prong grounded AC plug must be connected to a three-prong grounded AC outlet). If grounding methods are not possible, have a qualified electrician install a separate circuit breaker. Do not try to ground the unit by connecting it to telephone wires, lightning rods, or gas pipes.

21. Disconnect Device

The mains plug is the disconnecting device. The plug must remain readily operable.

As long as this unit is connected to the AC wall outlet, it is not disconnected from the AC power source even if you turn off this unit by SWITCH.

(Continued on next page)

IMPORTANT SAFETY INSTRUCTIONS

(Continued from previous page)

22. Outdoor Antenna Grounding

If an outside antenna or cable system is connected to the product, follow the precautions below.

An outdoor antenna system should not be located in the vicinity of overhead power lines or other electric light or power circuits or where it can come into contact with such power lines or circuits as death or serious injury can occur.

Be sure the antenna system is grounded so as to provide some protection against voltage surges and built-up static charges.

Article 810 of the National Electrical Code (NEC) in the U.S.A. provides information with respect to proper grounding of the mast and supporting structure, grounding of the lead-in wire to an antenna-discharge unit, size of grounding conductors, location of antenna-discharge unit, connection to grounding electrodes, and requirements for the grounding electrode.

Antenna Grounding According to NEC, ANSI/NFPA 70

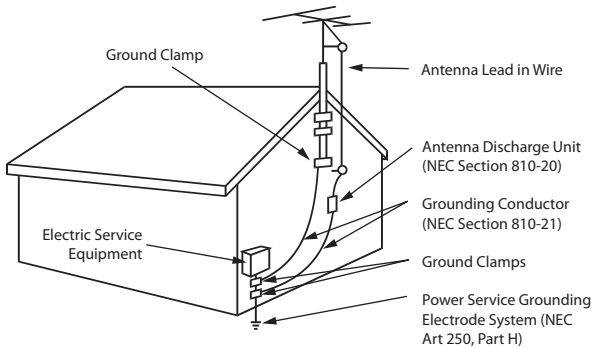

23. Cleaning

When cleaning, unplug the power cord and wipe gently with a soft cloth to prevent scratching. Do not spray water or other liquids directly on the STB as electric shock may occur. Do not clean with chemicals such as alcohol, thinners or benzene.

24. Transporting Product

Make sure the STB is turned Off and unplugged and that all cables have been removed. Do not press against or put stress on the STB.

25. Ventilation

Install the STB where there is proper ventilation. Do not install in a confined space such as a bookcase. Do not cover the STB with cloth or other materials (e.g., plastic) while it is plugged in. Do not install in excessively dusty places.

26. Do not touch the ventilation openings, as they may become hot while the STB is operating.
27. If you smell smoke or other odors coming from the STB or hear strange sounds, unplug the power cord, and contact an authorized service center.
28. Keep the product away from direct sunlight.

Table of Contents

Safety Warnings	2	FTG Mode of Operation	45–51
Important Safety Instructions	3–4	Creating an FTG Configuration File	45
Table of Contents	5	Teaching FTG Configuration to an STB	47
STB-2000 Introduction / Setup Checklist	6	Learning FTG Configuration from an STB	49
Introduction	6	Optional Manual Configuration / STB Setup	50
Setup Checklist	6	FTG File Manager Utilities Overview	52–55
STB-2000 Cabling Connections	7–8	FTG File Manager Main Screen	52
Connect the STB to the Display Panel	7	FTG Channel Map Configuration Utility	53
STB-2000 Cabling Diagram	8	FTG Channel Map Editor	54
Commercial Mode Overview	9–11	FTG Installer Menu Configuration Utility	55
Pass-through Mode	9	IP Environment Setup	56–63
FTG Mode	10	Accessing the IP Environment Menu	56
Determining the STB Operating Mode	11	Configuring the Network Connection	56
Pro:Centric Operation	12–13	Network Status	58
Pro:Centric Interactive Menu Features	12	IP Stream Control	59
Pro:Centric Interactive Menu Navigation	12	Pro:Centric Setup	60
Pro:Centric Setup	13	Wake On LAN Setup	61
Setting the Video Output Resolution	14	Media Share Setup	62
EZ-Manager Wizard	15–22	Pre-loaded Applications	63
Before You Begin	15	References	
Initiate Configuration or Exit the EZ-Manager Wizard	16	Upgrading STB Software using a USB Memory Device	64
TV Configuration Options	17	Display Panel Specifications	65
Zones and Room Number Assignments	17	STB Aux Input Configuration	66
Configure Pro:Centric Settings	19	Auto Input(s) Sensing Feature	67
USB Configuration	22	Restoring Factory Defaults on the STB(s)	68
LG Smart Install Utility	23–24	Using the STB's Zoning Features	69–72
Before You Begin	23	Wi-Fi Screen Share Features	73–75
Accessing and Using the LG Smart Install Utility	23	STB-2000 Jack Panels	76
Installer Menu	25–34	External IR Receiver Specifications	77
Accessing the Installer Menu	25	External Audio Line Out Specifications	78
Using the Installer Menu	26	Installer Remote Typical Key Functions	79
Exiting the Installer Menu and Activating Settings	26	STB Installer Remote	80
Custom Master STB Setup	35–38	Troubleshooting	81–83
Before You Begin	35	General Troubleshooting	81
Cloning Methods	35	STB Quick Check	82
Clonable STB Setup Menu Features	35	Commercial Mode Check	83
Custom Master STB Setup Procedure	36	Glossary of Terms	84
Channel Icons / Custom Text Labels (2-5-4 + MENU Mode)	39	Document Revision History / Open Source Software Notice	85
Cloning Procedures	40–44	Back Cover	86
Cloning Overview	40		
Learning / Teaching a Master STB Setup using a TLX File	40		
Learning / Teaching a Master STB Setup using a TLL File	43		

Notes

- Installer Menu content is intended for use primarily by qualified TV electronics technicians.
- Refer to the STB-2000 Owner's Manual for additional information on STB installation, specifications, maintenance, and safety instructions.
- Design and specifications subject to change without prior notice. This document provides examples of typical screen displays. Your displays may vary from those shown in this document.

STB-2000 Introduction / Setup Checklist

Introduction

The STB-2000 set-top box is designed to be connected to a compatible commercial display panel to create a system that can provide Pro:Centric[®] functionality, as well as either RF or IP content delivery. The STB-2000 may be used with LG Commercial Hospitality TVs (LP645H, LT670H, etc.) that support Multiple Protocol Interface (MPI), or the STB-2000 may be used with LG Commercial Public Display TVs (LD450C, LT560C, etc.) or LG Commercial Monitors (M3203CCBA, M3204C, etc.) that support the TV-Link Monitor (TLM) interface. The STB-2000 may also be used with commercial non-LG TVs that support SONIFI's Multiple Television Interface (MTI) protocol.

Setup Checklist

See also the STB-2000 Owner's Manual for information on STB installation and hardware and cable connections.

Installation and Setup

___ Unpack the STB and all accessories.

Accessories provided:

- AC/DC Power Adapter
- HDMI Cable
- MPI/MTI Cable (proprietary cable for LG MPI or SONIFI MTI control of display panel)
- TLM Cable (proprietary cable for LG TLM control of display panel)
- A/V Adapter Cable

___ Obtain an LG Installer Remote for configuration purposes.

If you are using an LG display panel, the LG remote provided with the display should be sufficient. If you are not using an LG display panel and/or if you intend to use multiple STBs/displays in a single room installation environment, an LG Installer Remote dedicated to STB control is available for purchase. For additional information and/or to purchase an STB Installer Remote, contact your LG service representative. See also Reference section, "STB Installer Remote."

___ Determine the installation location for the STB and display panel stand or mount.

___ Determine mounting and installation requirements, for example, AC power source outlet, antenna/cable service connectors, any external equipment required for system operation, all necessary cables, wires, and connectors, and any other additional required hardware, etc.

___ Install the display panel on VESA mount or stand.

Note: It may be advisable to make all cable connections before installing on VESA mount or stand.

Hardware Connections

___ Install any additional hardware as appropriate to your institution, LAN, etc.

Cable Connections

___ Make all connections to the STB jack panels, as described in this document.

Commercial Mode Setup

___ Complete appropriate procedures as described in this document for Commercial Mode operation.

STB-2000 Cabling Connections

This section describes how to connect the STB-2000 to a compatible commercial display panel (LG Hospitality TV, LG Public Display TV, LG Commercial Monitor, or commercial non-LG TV with MTI support).

Connect the STB to the Display Panel

The following procedure only describes those connections that are essential for STB functionality. See Reference section, “STB-2000 Jack Panels,” for further information on the additional jack panel ports and connectors.

Note: An LG Installer Remote (not supplied) is required to complete this procedure, as well as STB/display panel configuration procedures in this document. If you are using an LG display panel, a standard LG Installer Remote should be sufficient. However, if you are not using an LG display panel and/or if you wish to take advantage of the STB’s multi-code feature, LG’s STB-dedicated Installer Remote will be required. See Reference sections, “Installer Remote Typical Key Functions” and “STB Installer Remote,” for further information.

1. Turn ON the display panel. Before you connect the STB to the display panel, the display panel should be in a known state. That is, the display panel should be either in a factory default state or custom configured (in its default mode) with selected settings, for example, the aspect ratio, that you wish to use in conjunction with the STB.

When you are ready to proceed, leave the display panel turned ON, and then continue with step 2.

2. Refer to the STB-2000 Cabling diagram on the next page, and complete the following connections:
 - a) Make the appropriate Display Control connection between the STB-2000 and the display panel.
 - For LG Hospitality TVs: Use the MPI/MTI cable provided to connect DISPLAY CONTROL 2 on the STB-2000 front jack panel to the MPI port on the rear jack panel of the display.
 - For LG Public Display TVs or LG Commercial Monitors: Use the TLM cable provided to connect DISPLAY CONTROL 1 on the STB-2000 rear jack panel to the RS-232 CONTROL connector on the rear jack panel of the display.
 - For commercial non-LG TVs: Use the MPI/MTI cable provided to connect DISPLAY CONTROL 2 on the STB-2000 front jack panel to the MTI (typically labeled “DATA”) port on the rear jack panel of the display.
 - b) Use the HDMI cable provided to connect HDMI OUT on the STB-2000 rear jack panel to the HDMI1 input connector on the rear jack panel of the display.
 - c) Connect a 75 ohm coaxial wire from the Antenna/CATV wall jack to ANTENNA/CABLE IN on the STB-2000 rear jack panel.
 - d) Insert the DC power plug of the AC/DC power adapter provided into the POWER connector on the rear jack panel of the STB-2000, and then plug the AC/DC adapter into a standard 120V 60 Hz AC power outlet.

Once power is applied to the STB-2000, the LED on the STB’s front jack panel will light steadily, indicating that the STB is in standby mode. Also, the display panel will be turned OFF by the STB as soon as the STB is powered and establishes display control communication with the display.

Note: Once display control communication is established between the STB-2000 and the display panel, the STB-2000 will be in control of the display panel, and certain resident panel functions, like panel buttons, will no longer operate.

3. Use the Installer Remote to turn ON the STB/display panel.

(Continued on next page)

STB-2000 Cabling Connections (Cont.)

(Continued from previous page)

While the STB is turning ON and sending the turn ON command to the display, the STB LED blinks at a constant rate. Once both the STB and the display panel are ON, the STB LED remains lit but blinks off twice in rapid succession every five seconds. The first image you should see on the display panel is the Setting a Resolution screen from the STB (see “Setting the Video Output Resolution” on page 14).

4. Select the video output resolution (i.e, the STB’s video output format), and complete the appropriate Commercial Mode setup procedures, as described in this document.

Note: It is recommended that you complete STB-2000 Commercial Mode setup procedures before you make external equipment connections to the STB-2000.

STB-2000 Cabling Diagram

See also step 2 of procedure above.

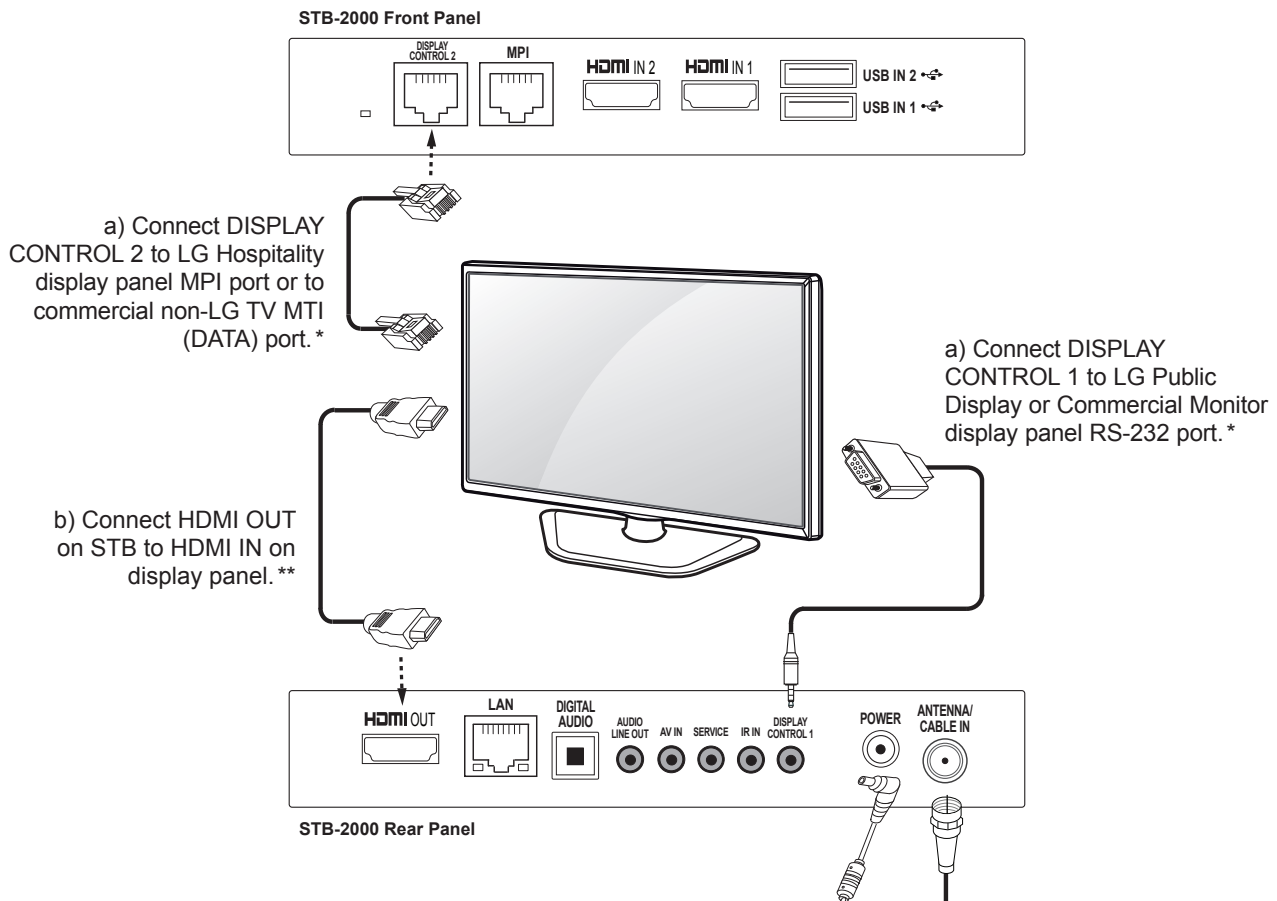

* Only one DISPLAY CONTROL connection should be used, depending on the type of display panel to be controlled.

** The STB default configuration automatically sends Display Control commands to switch the connected display panel to its HDMI1 input.

This document describes how to set up the STB-2000 for Commercial Mode operation. LG commercial STB functionality is based on “ownership” of the Channel Map; that is, the Channel Map resides in the STB’s CPU or Protocol Translator Card (PTC) or it resides externally from the STB (i.e., in a device from the solution provider). The STB-2000 is capable of Free-To-Guest (FTG) Mode operation via the STB CPU. Alternatively, the STB can be configured for Pass-through Mode (default). When in Pass-through Mode, the STB-2000 may also be controlled externally via its MPI port.

Pass-through Mode

This mode allows you to configure individual STBs for Pro:Centric and/or FTG Mode via CPU operation or create a Master STB Setup for cloning purposes. This mode also allows external control via the MPI port on the STB jack panel. There are two methods for configuring individual STBs that are currently in Pass-through Mode: either using the EZ-Manager Wizard or the Custom Master STB Setup procedure.

EZ-Manager Wizard

When the STB is in a factory default state, the EZ-Manager Wizard provides automated or manual options for configuring essential items for Pro:Centric operation and also provides an option for using a USB memory device to configure the STB. Use the Installer Remote to make selections and complete each step. See “EZ-Manager Wizard” on pages 15 to 22 for detailed information.

Custom Master STB Setup

The Custom Master STB Setup procedure enables you to create a customized Master STB Setup for cloning purposes for STBs that are to remain in Pass-through Mode. Use the Installer Remote to configure Installer Menu items as required for STB operation and set up STB features (Channel, Picture, Audio, etc.). See “Custom Master STB Setup” on pages 35 to 38 for detailed information.

Installer Menu

To create a Master STB Setup, you will need to know how to access the commercial controller (PTC) Installer Menu and make changes to the default values as required. If necessary, familiarize yourself with the Installer Menu and how to make and save changes. Refer to pages 25 to 34 for information on accessing the Installer Menu and for detailed descriptions of the Installer Menu items.

STB Setup Menus

On-screen setup menus control the features of the STB/display. Use the Installer Remote to access the STB setup menus, and set the STB/display features to the desired configuration for the end user.

Cloning

Cloning refers to the process of capturing a Master STB Setup and transferring it to a Target STB. Both STBs must be identical models. The Master STB’s clonable setup menu features should be configured as part of the Master STB Setup. If there are features in the Master STB’s setup—channel icons or labels, digital font options, etc.—that are not set or that are set incorrectly, those features also will not be set or will be set incorrectly in the Target STBs. Refer to pages 40 to 44 for detailed information on cloning requirements and procedures.

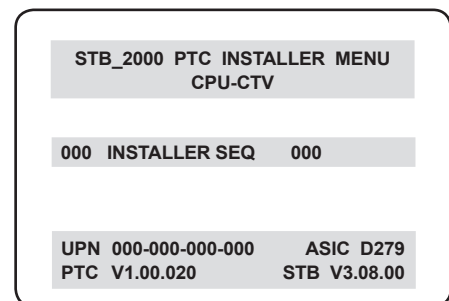

Typical Installer Menu

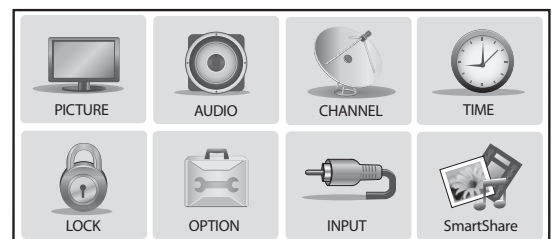

STB Setup Menus

Commercial Mode Overview (Cont.)

External MPI Control

To control the STB using an external MPI control device, you must use the STB's MPI port for communication purposes.

Note: The STB-2000 is not equipped with an MPI card slot.

FTG Mode

In this mode, the STB's CPU is configured with an FTG Channel Map, and the CPU controls and restricts the tuning operation of the STB based on this FTG Channel Map. The FTG Channel Map enables the decryption of each Pro:Idiom[®] encrypted channel and also provides logical channel mapping of physical RF channels (analog and digital) and Aux inputs.

Note: Logical channel mapping of physical RF channels eliminates dash tuning (for example, physical 19-3 can be mapped to logical channel 9). Physical channel tuning requires that you include the dash when direct entering channel numbers.

FTG Mode Features

FTG Mode provides the following features:

- Logical tuning of physical RF channels and Aux inputs.
- Logical tuning of IP channels.
- Mapping of RF channels with minor (program) numbers up to 999.
- FTG Channel Map of up to 600 logical channels.
- Start Channel set for RF, Aux input, or IP delivered content.
- Pro:Centric data delivery over RF or IP.
- TV Zoning and Wi-Fi Zoning options for location-specific configuration.

LG's FTG File Manager PC software enables you to create an FTG Configuration (.tlx) file, which may be used to configure the CPU for FTG Mode. FTG File Manager utilities enable you to create/edit an FTG Channel Map and configure Installer Menu settings. You can also save (Learn) a TLX file from a Master STB.

In this mode, the STB's CPU must be configured with an FTG Channel Map and FTG Installer Menu settings using one of the following processes:

- **Local:** Configure an individual STB-2000 via its USB port using a USB memory device / TLX file. The "Teach to STB (TLX)" process and associated procedures for FTG mode configuration are described on pages 45 to 51.
- **Remote:** Configure all STB-2000s at the site using a Pro:Centric server head end device (Example: PCS150R). Load a TLX file on the Pro:Centric server using the TV E-Z Installation "Configuration" option in the Pro:Centric server Admin Client. Refer to the ***Pro:Centric Server Admin Client User Guide*** for further information.

Commercial Mode Overview (Cont.)

While the STB is in FTG Mode:

- Users can still access the Installer Menu using an LG Installer Remote; however, all Installer Menu items will be read-only.
- Any FTG configuration changes must be made using a TLX file (typically edited in the FTG File Manager). The FTG File Manager's FTG Channel Map Configuration and FTG Installer Menu Configuration Utilities enable you to make changes, respectively, to the FTG Channel Map and FTG Installer Menu settings as necessary. See information on local configuration in this document or refer to documentation for the server for information on remote management.
- If it becomes necessary to restore the STB to Pass-through Mode, there are several options that will enable you to do so. See Reference section, "Restoring Factory Defaults on the STB(s)," for further information.

Pages 52 to 55 provide overviews of the utilities that comprise the FTG File Manager. Refer to the **Free-To-Guest (FTG) File Manager User Guide** for further information on the FTG File Manager.

Remote Management in FTG Mode

When the STB is configured for FTG Mode, remote management of the FTG Channel Map and FTG Installer Menu settings is provided by a Pro:Centric server, via a TLX file loaded on the Pro:Centric server Admin Client. Refer to the **Pro:Centric Server Admin Client User Guide** for further information.

Determining the STB Operating Mode

To determine the operating mode of the STB, press **MENU** on the Installer Remote. The menu displayed depends on the operating mode. See examples below.

If the Function Menu appears, the STB is in a mode (FTG, PPV, etc.) that does not allow the end user to change the fundamental STB setup. If the STB setup menus appear, the STB is in Pass-through Mode.

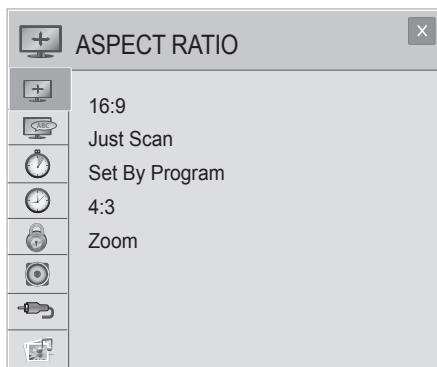

Function Menu

Indicates the STB is not in Pass-through Mode. While the STB is in this mode, Installer Menu settings can be accessed as read-only.

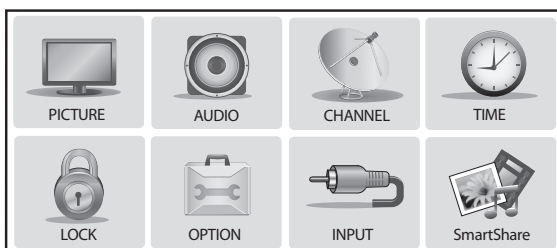

STB Setup Menus

Shows that the STB is in Pass-through Mode.

Pro:Centric Operation

Pro:Centric Interactive Menu Features

LG's Pro:Centric application enables guests to locate and select television entertainment using an interactive channel guide, check the daily weather, and view hotel and surrounding amenities via custom billboards and points-of-interest maps.

Pro:Centric application features include:

- Portal and information screens/pages (including a "Welcome" page) that include branding logos.
- An optional customized user interface (custom "skins").
- Billboards and points-of-interest maps that can be customized to focus on hotel amenities, local attractions and businesses, restaurants, news, events, etc.
- An optional Weather billboard that includes a local radar map, current conditions, and a four day forecast.
- An interactive channel guide that provides a channel list with channel icons. An electronic program guide (EPG) is an optional feature that displays up to three days of programming information viewable by channel and time.
- Video spooling that enables the hotel to deliver a video file to guest TVs for promotion and information purposes.

The Pro:Centric server Admin Client web editor/content wizard is provided for customer configuration of portal messages and billboards/maps.

Note: Customized content is typically defined by the service integrator and/or hotel administrators. LG does not provide hotel-specific content.

Pro:Centric Interactive Menu Navigation

An LG Pro:Centric-capable remote control provides access to both interactive menus and regular STB/display features. Press **PORTAL** on the remote to access the interactive menus.

Note: Interactive menu options may vary, depending on Pro:Centric features enabled for the site. The following are default interactive menus.



Channel Guide

Shows available TV networks and logical channels. When available, EPG data provides additional channel and program information.

Information

Typically displays information on hotel amenities, for example, restaurants, in-room dining, business centers, facilities, etc., as well as information on local weather and attractions.

Help

Provides help for navigating the interactive menus.

Watch TV

Removes the interactive menu from the screen and returns to the previously tuned TV channel.

Pro:Centric Setup

Administration and management options for the Pro:Centric server are described in detail in the **Pro:Centric Server Admin Client User Guide**. This document describes only those settings that must be specified on the STB to enable Pro:Centric remote management and/or the Pro:Centric application.

- Remote management (TV E-Z Installation): The Pro:Centric server Admin Client provides remote management facilities for downloading software/firmware updates as well as facilities for downloading a TLX file for FTG Mode configuration.
- Pro:Centric application: The application, which operates in conjunction with FTG and PPV Modes, comprises the Pro:Centric interactive menus/features described on the previous page. Pro:Centric application settings are managed via the Pro:Centric Admin Client.

The Pro:Centric server settings can be configured using one of the methods described below.

STB in Factory Default State

When the STB is in a factory default state, the EZ-Manager Wizard provides automated or manual options for configuring the Pro:Centric server settings.

The EZ-Manager Wizard also provides a USB Configuration option that enables you to configure an STB for FTG Mode using an FTG Configuration (.tx) file stored on a USB memory device. The FTG Configuration file incorporates FTG Installer Menu settings, which includes Installer Menu items 098 PRO:CENTRIC and 119 DATA CHANNEL.

Refer to “EZ-Manager Wizard” on pages 15 to 22 for further information on the EZ-Manager Wizard options.

Note: If Pro:Centric data delivery will be over IP and there is a DNS server at the site, you can create a “procentric.local” DNS entry for the Pro:Centric server that will enable automated Pro:Centric IP configuration via the EZ-Manager. If there is no DNS entry for procentric.local, you will need to manually enter the Pro:Centric server IP address and port number during configuration.

STB in Pass-through Mode

If the STB is in Pass-through Mode, either:

- Set Installer Menu items 098 PRO:CENTRIC and 119 DATA CHANNEL to the appropriate values. Refer to “Installer Menu” information on pages 25 to 34 for further information. Also, as necessary, refer to “Custom Master STB Setup” information on pages 35 to 38 and/or cloning information on pages 40 to 44.
- Configure the appropriate Pro:Centric server settings in the IP Environment / Pro:Centric Menu. You must use this option, in particular, if you wish to configure IP settings for the Pro:Centric server. See “Accessing the IP Environment Menu” on page 56 and “Pro:Centric Setup” on pages 60 to 61 for further information.

Note: When the STB is in either Pass-through Mode or FTG Mode, you can also leave Installer Menu item 119 DATA CHANNEL set to its default value (255) to enable the STB’s Data Channel Auto Search feature to set the DATA CHANNEL value. See item 119 description on page 33 for additional information.

STB in FTG Mode

If the STB is in FTG Mode, use the FTG File Manager software to update Installer Menu items #98 Pro:Centric and #119 Data Channel (along with their affiliated fields). Then, transfer the FTG Installer Menu settings to the STB. Refer to the FTG Mode overview on pages 10 to 11 for further information on FTG Mode operation and configuration. Also, see note above regarding the option to use the STB’s Data Channel Auto Search feature to set the DATA CHANNEL value.

Setting the Video Output Resolution

The first time you turn ON the STB/display panel, the Setting a Resolution screen will be displayed, and you will need to select the appropriate option—720p, 1080p, or 1366 x 768—for the STB's video output format. You cannot proceed with STB configuration until you make a selection.

Refer to documentation for the applicable display panel(s) to determine the appropriate resolution setting. The selected resolution should be compatible with the display panel's native screen resolution.

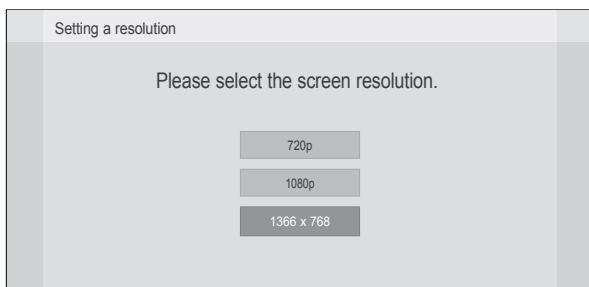

1. Use the Up/Down arrows on the Installer Remote to select the appropriate video output resolution option, and then press **OK**.

The STB's default video output resolution is 720p. If you select this option, the Setting a Resolution screen will close and the EZ-Manager Wizard Welcome screen will be displayed (see pages 15 to 22 for information on the EZ-Manager Wizard). Proceed with Commercial Mode setup as required.

If you select one of the other two resolution options (1366 x 768 is highlighted as the recommended resolution), the STB will reboot within a few seconds to change the resolution per your selection. Continue with step 2.

2. When the STB reboot is complete, you will be prompted to confirm the new video output resolution. Use the arrow keys on the Installer Remote to select **OK** in the confirmation window, and then press **OK** on the Installer Remote.

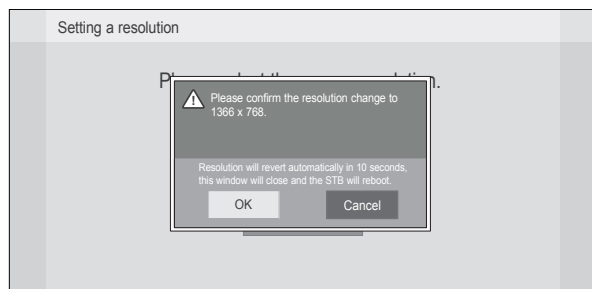

Note: If there is no user interaction within 10 seconds, or if you select “Cancel” in the confirmation window, the STB will reboot and revert to the default resolution. After this reboot is complete, the Setting a Resolution screen will be redisplayed.

Once you confirm the new screen resolution, the EZ-Manager Wizard Welcome screen will be displayed. Proceed with Commercial Mode setup as required.

Note: If required at a later time, you can also change the screen resolution in the STB Installer Menu (item 105 VID OUT FORMAT) or, if applicable, the FTG File Manager (#105 Output Format).

The primary purpose of the EZ-Manager Wizard is to guide you through the process (automated or manual) of configuring the essential Installer Menu items for Pro:Centric operation. The wizard is initiated once the video output resolution is set (see previous page) and subsequently each time the STB/display panel is turned ON, until one of its configuration methods has been completed or the wizard is exited. Use the Installer Remote to make selections and complete each wizard step.

While the EZ-Manager Wizard is intended primarily for Pro:Centric-related configuration, the wizard also offers Zoning as well as USB configuration options.

- STB-2000s support the TV Zoning and Wi-Fi Zoning features, both of which enable location-specific settings (see Reference section, “Using the STB’s Zoning Features,” for further information). The EZ-Manager Wizard enables you to set the TV Zone # and/or the Wi-Fi Zone # in the STB as part of the configuration process.
- The EZ-Manager Wizard also enables you to redirect to the STB’s standard USB Download Menu as part of the configuration process, if desired, to perform USB configuration functions, including FTG Mode configuration, cloning, and software upgrades.
- You can connect a USB memory device to the STB at any time while the wizard is in progress (starting at the Welcome screen) to use the LG Smart Install utility to perform USB configuration functions. Any file(s) you wish to use for configuration purposes must be stored in a folder named “LGSMARTINSTALL” in the root directory of the USB memory device. See “LG Smart Install Utility” on pages 23 to 24 for further information.



Caution: Do NOT unplug the STB power cord or remove the antenna cable or, if applicable, the LAN cable during the configuration process, as doing so will interrupt the current step and may corrupt the configuration data.

Before You Begin

- If you plan to create a Master STB Setup using the procedure described on pages 35 to 38, be sure to exit the EZ-Manager Wizard in order to avoid setting modes that may restrict the custom setup procedure. See also “Initiate Configuration or Exit the EZ-Manager Wizard” on the following page.
- If it has been completed or exited and therefore does not display, the EZ-Manager Wizard can be reactivated; however, this requires that you restore the STB to a factory default condition. See Reference section, “Restoring Factory Defaults on the STB(s),” for further information.
- Each wizard step is allotted a time frame after which the wizard proceeds without user interaction. If the Pro:Centric server is configured on the system and if no location-specific settings are required in the STB, for example, TV Zone, Wi-Fi Zone, Label, and/or Room Number settings, you can simply turn ON the STB/display, and once initiated, the wizard will proceed through each of the configuration steps with no further user interaction.
- If any of the configuration steps fails, you will see a “Diagnostics” screen with an indication of the failure. You will then have the opportunity to reinitiate the configuration process from the previous screen or exit the EZ-Manager Wizard.
- If you wish to enable media sharing (i.e., Smart Share, Wi-Fi Screen Share, and DMR) on the STB without using a TLX file for configuration purposes, you will need to create a custom Master STB Setup and use the IP Environment Menu to specify the settings. Custom Master STB Setup is described on pages 35 to 38. Refer to “IP Environment Setup” on pages 56 to 63 for information on the IP Environment Menu.

EZ-Manager Wizard (Cont.)

Initiate Configuration or Exit the EZ-Manager Wizard

The Welcome screen provides a brief introduction to the EZ-Manager wizard.



Note: If there is no user action in this screen within 10 seconds, the wizard will proceed to the first configuration step. Once the wizard has proceeded, it is not possible to return to the Welcome screen; however, if you simply wish to exit the wizard, you can do so by selecting the “Exit” option from the subsequent screen(s).

Note: As indicated on the previous page, you may use the LG Smart Install feature to configure the STB/display using a USB memory device at any time while the EZ-Manager Wizard is in progress. However, if you want to use the Zoning feature(s) on the STB for location-specific configuration purposes, proceed to the EZ-Manager’s Zones, Label, and Room Number screen and assign the appropriate TV Zone # and/or a Wi-Fi Zone # for this STB before inserting your USB device. See “TV Configuration Options” on the following page for further information.

From the Welcome screen, you have the following options:

- To proceed with the EZ-Manager Wizard, use the arrow keys on the Installer Remote to select/highlight **Next** and press **OK**. Then, continue to the “TV Configuration Options” section on the following page.
- To exit the wizard, but retain the use of the Pro:Centric remote management feature on this STB (i.e., Installer Menu item 119 DATA CHANNEL set to 255) in the future, use the arrow keys on the Installer Remote to select/highlight **Exit** and press **OK**. In the confirmation pop-up window, select **OK**, and then press **OK** once more on the Installer Remote.
- If you do not intend to install a Pro:Centric server on this system and you do not wish to use the wizard’s Zoning or USB configuration options, exit the wizard as follows: Use the arrow keys on the Installer Remote to select/highlight the **No Pro:Centric** option. This will disable the Pro:Centric feature of this STB (i.e., Installer Menu item 119 DATA CHANNEL will be set to 0) and exit the wizard. In the confirmation pop-up window, select **OK**, and then press **OK** once more on the Installer Remote.

TV Configuration Options

From the TV Configuration Options screen, you can choose how to proceed with the configuration of this STB/display (assuming you do not opt to exit the wizard, which you may also do at any time).

 **Note: If you intend to use the Zoning feature(s) on the STB for location-specific configuration purposes, select the “Zones & Room Number” option from this screen and assign the appropriate TV Zone # and/or the Wi-Fi Zone # in the STB BEFORE you continue with additional configuration.**

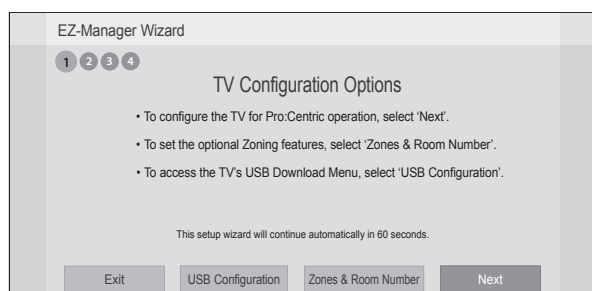

Note: If there is no user action in this screen within one minute, the wizard will automatically continue to the next configuration step.

Use the Left/Right arrow keys on the Installer Remote to navigate between options on this screen. Each time you select/highlight one of the following options, the screen text and fields will change in accordance with your selection.

- To continue with Pro:Centric configuration, select **Next** (default) and press **OK** on the Installer Remote. Refer to “Configure Pro:Centric Settings” on pages 19 to 21 for additional information.
- To set the Zoning feature(s) on the STB, select **Zones & Room Number**. See “Zones and Room Number Assignments” below for further information.
- Select **USB Configuration** to access the STB’s USB Download Menu. See “USB Configuration” on page 22 for further information.

Note: If you have already inserted a USB memory device with the intent to use the LG Smart Install utility and the Integrated USB Downloading screen is on display, you may still set the Zoning features on this STB by selecting **Previous** to return to the EZ-Manager’s TV Configuration Options screen. Set the Zoning features as required, and then select **USB Configuration** and press **OK** on the Installer Remote to return to the Integrated USB Downloading screen.

Note: If you choose to exit the EZ-Manager Wizard from this point on, you will have the option to save any settings made by selecting **Save and Exit** in the exit confirmation pop-up window. Or, you can exit the wizard without saving any settings by simply selecting **OK** in the confirmation pop-up window.

Zones and Room Number Assignments

You may complete one or more of the fields in the Zones, Label, and Room Number screen or leave them at their default settings (TV Zone and Wi-Fi Zone) or blank (Label and Room Number), as desired. However, if you intend to use either of the Zoning features—TV Zoning and/or Wi-Fi Zoning—on this STB, you **MUST** specify the appropriate values in the TV Zone and/or Wi-Fi Zone fields as described on the following page. See also Reference section, “Using the STB’s Zoning Features,” for further information.

EZ-Manager Wizard (Cont.)

Note: Zoning features are only applicable for STBs that will be configured using a TLX file (local or remote configuration).

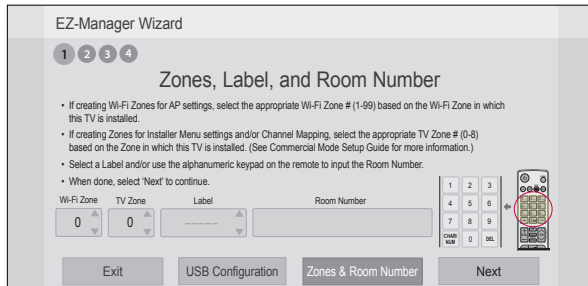

1. Complete the appropriate field(s) as described below. Use the Left/Right arrow keys on the Installer Remote to navigate between each of the fields.
 - **Wi-Fi Zone:** Enables you to set a Wi-Fi Zone # so that the STB can be configured with a particular access point's login data for wireless networking. Login data (i.e., SSID, security type, and security key) may be provided in a TLX file to be used for configuration. If the Wi-Fi Zone # is left at its default value (0), the STB will not be configured with login data from a TLX file.

To assign a Wi-Fi Zone, navigate to the Wi-Fi Zone field at the far left of the screen, and use the Up/Down arrow keys to specify the desired Wi-Fi Zone # (1–99).
 - **TV Zone:** Enables you to set a TV Zone # so that the STB can be configured with Installer Menu and/or TV Setup Menu settings intended only for the assigned Zone. The Installer Menu and/or TV Setup Menu settings may be provided in a TLX file to be used for configuration. If the STB is being configured for FTG Mode, the TV Zone # setting also allows the STB to omit channels that have been restricted in the FTG Channel Map.

To change the TV Zone from its default value (0), navigate to the TV Zone field, and use the Up/Down arrow keys to specify the desired TV Zone # (1–8).
 - **Label:** Allows you to select a North, South, East, or West text label for this STB. In the Label field, use the Up/Down arrow keys to select the applicable label.
 - **Room Number:** Allows you to specify the number of the room in which the STB is located. In the Room Number field, you can use the number keys on the Installer Remote to direct enter a room number. Use the Dash key on the Installer Remote as necessary to toggle between number and letter characters in the Room Number field. Also, you can use the Flashback key on the Installer Remote to delete characters in this field.
2. When you are ready to continue, select the appropriate option, as follows:
 - To proceed to the next EZ-Manager screen, use the arrow keys to select **Next**, and then press **OK** on the Installer Remote. Continue to the “Configure Pro:Centric Settings” section on the following page.
 - If you wish to use a USB memory device in conjunction with the STB’s standard USB Download Menu to complete the configuration, continue to “USB Configuration” on page 22.
 - If you wish to use a USB memory device in conjunction with the LG Smart Install utility to complete the configuration, see “LG Smart Install Utility” on pages 23 to 24.

Configure Pro:Centric Settings

Once you select “Next” from the TV Configuration Options screen, the Searching for Pro:Centric Server screen is displayed (see example at right), and you have the following options:

- You can allow the EZ-Manager Wizard to proceed with a series of automated steps to configure the STB for Pro:Centric operation and then to look for the Pro:Centric application and maintenance (E-Z Installation) files to download. In this case, the wizard uses a search algorithm to determine the Data Channel and the Pro:Centric Application Mode to set in the STB.

Continue with the “Automated Pro:Centric Configuration” subsection below.

- If you already know the settings (i.e., Data Channel and Pro:Centric Application Mode) that need to be configured in order for the STB to connect to the Pro:Centric server and/or if the Pro:Centric server is not yet installed, you may expedite the setup process by entering this data manually.

Continue with the “Manual Pro:Centric Configuration” subsection on the following page.

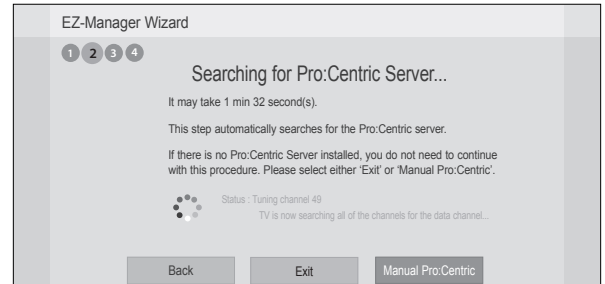

Note: You can select the “Back” button, where available, to check previous settings, as necessary.

Automated Pro:Centric Configuration

Note: If the server is not yet configured on the system, use the manual configuration option to configure the Pro:Centric operation. See also note below.

Note: If Pro:Centric data delivery will be over IP and there is a DNS server at the site, you can create a “procentric.local” DNS entry for the Pro:Centric server that will enable automated Pro:Centric IP configuration via the EZ-Manager. If there is no DNS entry for procentric.local, you must use the manual configuration option to configure the Pro:Centric IP operation.

Once the Pro:Centric data channel is found (the Pro:Centric Server Was Found screen will be displayed—see example at right) and the Pro:Centric Application Mode is determined, the wizard will advance to the Processing the Pro:Centric Configuration screen, which shows the progress of the data downloads. Note that some steps may require a few minutes.

If the process is successful, no further user interaction is required, though, in some instances, where the option (for example “Next”) is available, you may manually move forward to subsequent steps within the wizard to speed up the process.

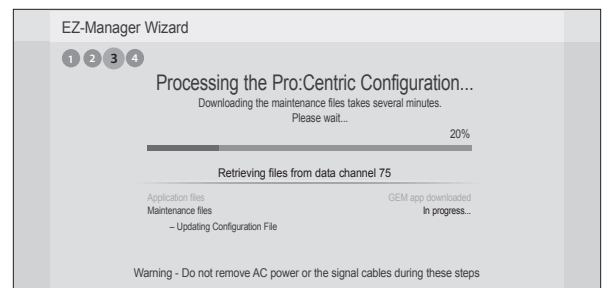
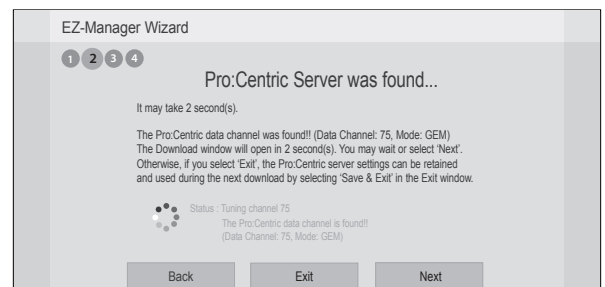

(Continued on next page)

EZ-Manager Wizard (Cont.)

(Continued from previous page)

Note: If, after completing the search, the STB is unable to find the Pro:Centric data channel (while the Searching for Pro:Centric Server screen is on display), the wizard will stop and show a Diagnostics screen that enables you to manually return to the previous screen (to reinitiate the configuration) or exit the wizard.

When the Pro:Centric Configuration is complete, an EZ-Manager Configuration Complete screen is displayed, and after 10 seconds, the wizard exits, and the STB turns OFF.

Note: With the EZ-Manager Configuration Complete screen on display, you can also manually turn off or reboot the STB. If desired, select **Turn Off** or **Reboot**, respectively, and then press **OK** on the Installer Remote.

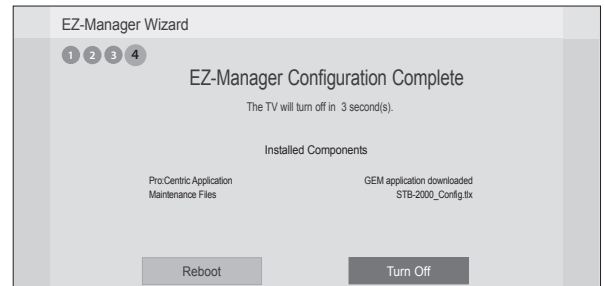

Manual Pro:Centric Configuration

1. With the Searching for Pro:Centric Server screen on display, use the arrow keys on the Installer Remote to select/highlight the **Manual Pro:Centric** option at the bottom right of the screen, and press **OK**.

In the Pro:Centric Manual Configuration screen (see examples at right below and on following page), you will be able to configure the appropriate Pro:Centric settings in the STB. Use the Up/Down arrow keys on the Installer Remote to navigate between fields.

2. In the Pro:Centric Mode field, use the Left/Right arrow keys to select the appropriate Pro:Centric Application Mode—GEM, FLASH, HTML, or Configuration Only.

Note: For remote management only, select “Configuration Only.” The STB will search for TV E-Z Installation data downloads; however, Pro:Centric application data will not be downloaded, i.e., Installer Menu item 098 PRO:CENTRIC will be set to 0.

3. Refer to the appropriate subsection below, depending on the Pro:Centric server configuration, to complete the remaining fields.

RF Configuration

- a) In the Media Type field, use the Left/Right arrow keys to select **RF**.
- b) In the Data Channel field, either key in or use the Left/Right arrow keys to select the RF channel number that will be used by the Pro:Centric server as its data channel. The Data Channel value can be set from 1 to 135. *

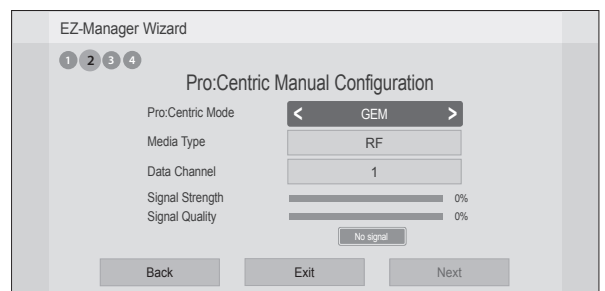
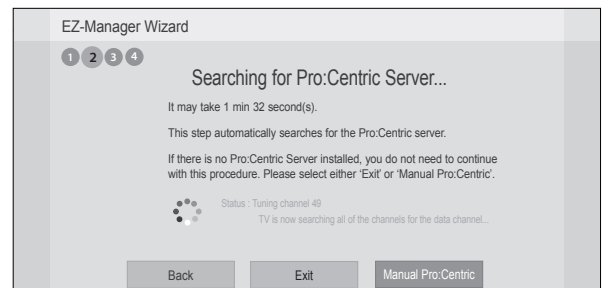

Pro:Centric Manual Configuration Screen with RF Media Fields

(Continued on next page)

* PCS150R and later Pro:Centric servers do not support HRC or IRC cable channel frequencies.

(Continued from previous page)

IP Configuration

- a) In the Media Type field, use the Left/Right arrow keys to select **IP**.

Note: By default, the Pro:Centric Manual Configuration screen initially shows RF configuration fields. When you select “IP” as the Media Type, the Data Channel and Signal Strength fields are replaced with (IP) Address and Port fields.

- b) In the Address and Port fields, either key in or use the Left/Right arrow keys to select the appropriate values for the Pro:Centric server IP address and port number.

The IP address must match the IPv4 multicast address and the port number must match the port number that is set in the Pro:Centric server.

4. Once all fields are completed as required, you have two options (see also note below):
 - To save the data entered and exit the wizard, use the arrow keys to select **Exit** and then press **OK**. In the subsequent pop-up confirmation window, select **Save and Exit**, and then press **OK** once more. The Pro:Centric application and/or E-Z Installation data will be downloaded to the STB at a later time. This option is useful, in particular, if the Pro:Centric server has not yet been configured.
 - To initiate a real-time download of Pro:Centric application and/or E-Z Installation data, use the arrow keys to select **Next**, and then press **OK**.

The EZ-Manager Wizard will proceed with the remaining Pro:Centric application and/or E-Z Installation data download steps, as shown on the Processing the Pro:Centric Configuration screen.

Note: With RF configuration, Pro:Centric server data must be present on the RF channel selected as the STB’s Data Channel in order for you to select “Next” (you will see a “Data Channel found” message below the signal strength indicator). With IP configuration, Pro:Centric server data must be present via the wired LAN cable connection in order for you to select “Next” (you will see an “IP server found” message below the Port field).

When the Pro:Centric configuration is complete, an EZ-Manager Configuration Complete screen is displayed, and after 10 seconds, the wizard exits, and the STB turns OFF.

Note: With the EZ-Manager Configuration Complete screen on display, you also have the option to manually turn off or reboot the STB. If desired, select **Turn Off** or **Reboot**, respectively, and then press **OK** on the Installer Remote.

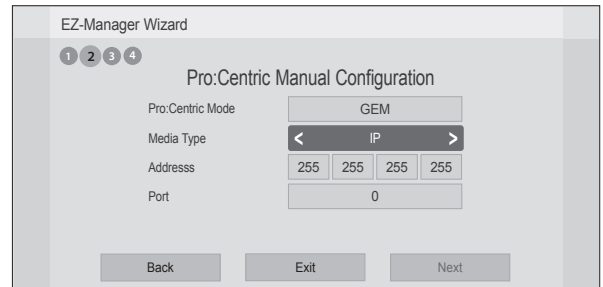

Pro:Centric Manual Configuration Screen with IP Media Fields

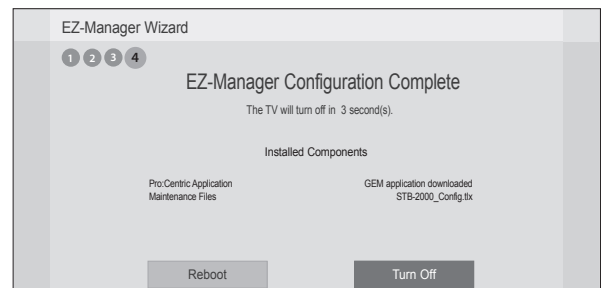
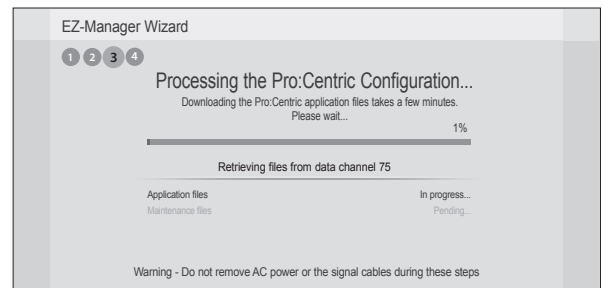
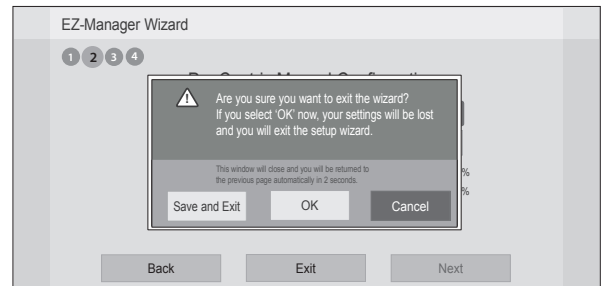

EZ-Manager Wizard (Cont.)

USB Configuration

The USB Download Menu provides options that enable you to download individual configuration or software files to the STB.

Each of the USB Download Menu functions requires that you have the appropriate file(s) loaded on a USB memory device. If you wish to perform a software upgrade from the USB Download Menu, the software upgrade file(s) must be stored in a folder named “LG_DTV” in the root directory of the USB device. TLX/TLL files for cloning or FTG Configuration (.tlx) files should simply be stored in the root directory of the USB device.

The procedure below assumes that the desired file(s) is/are already loaded onto the USB device. For further information on USB Download Menu functions and file requirements, and/or for information on creating configuration files, refer to the appropriate section(s) in this document.

Before You Begin

- Ensure the USB device to be used has been formatted with FAT format.
- If you intend to use the Zoning feature(s) on this STB, make sure to assign the appropriate TV Zone # and/or Wi-Fi Zone # in the EZ-Manager’s Zones, Label, and Room Number screen BEFORE continuing with USB Configuration. See “TV Configuration Options” on page 17 for further information.
- Refer to “Custom Master STB Setup” on pages 35 to 38 for information on creating a TLX or TLL file for cloning purposes, and/or refer to “Creating an FTG Configuration File” on pages 45 to 46 for information on creating an FTG Configuration (.tlx) file for FTG Mode configuration.
- See Reference section, “Upgrading STB Software using a USB Memory Device,” for further information on software upgrades.

USB Configuration via EZ-Manager Wizard

With either the TV Configuration Options or the Zones, Label, and Room Number screen on display, proceed as follows to configure the STB/display using the USB memory device.

1. Insert the USB memory device that contains the appropriate file(s) into either of the STB’s USB ports.
2. Use the arrow keys on the Installer Remote to select **USB Configuration**, and then press **OK**.

You will be redirected to the STB’s USB Download Menu (see example at right).

3. Select the appropriate option from the USB Download Menu, and complete the download as required.

Note: If you perform a software upgrade, the STB will complete the upgrade and then reboot. Upon restart, the EZ-Manager TV Configuration Options screen will be displayed on the screen. If desired, you can re-access the USB Download Menu (to perform additional functions), proceed with configuration via the wizard, or exit the wizard.

4. Remove the USB memory device, and verify that the appropriate configuration is resident on the STB.

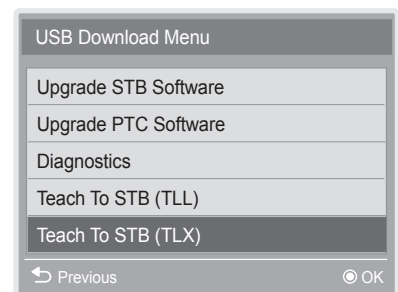

Note: You can press ↵ on the Installer Remote at any time to return to the EZ-Manager Wizard.

The LG Smart Install utility enables you to select multiple files at one time from the files loaded on a USB memory device. You may use this utility to download any one or all of the following to an STB: a TLX file for configuration purposes, an STB (CPU) software update, a PTC software update.

Before You Begin

- Ensure the USB device has been formatted with FAT format.
- All files must be stored in a folder named “LGSMARTINSTALL” in the root directory of the USB memory device.
- Cloning using a TLL file is only available from the STB’s USB Download Menu.
- Refer to “Custom Master STB Setup” on pages 35 to 38 for information on creating a TLX file for cloning purposes, and/or refer to “Creating an FTG Configuration File” on pages 45 to 46 for information on creating an FTG Configuration (.tlx) file for FTG Mode configuration.
- See Reference section, “Upgrading STB Software using a USB Memory Device,” for further information on software upgrades.



Caution: Do not unplug the STB power cord or remove the USB memory device during a data download, as doing so may cause the STB to malfunction or harm the USB device, respectively.

Accessing and Using the LG Smart Install Utility

1. If it is not ON already, turn ON the STB/display panel.
 2. The next step depends on whether the EZ-Manager Wizard appears on the screen when you turn ON the STB/display:
 - If the wizard is displayed, you can insert the USB memory device that contains the appropriate file(s) into either of the STB’s USB ports at any time to initiate the LG Smart Install utility. With the LG Smart Install utility Integrated USB Downloading screen on display (see example on following page), continue with step 4.
 - If the wizard is not displayed, insert the USB memory device that contains the appropriate file(s) into either of the STB’s USB ports, and continue with step 3.
-  **Note: If you intend to use the Zoning feature(s) on this STB for location-specific configuration purposes, make sure to assign the appropriate TV Zone # and/or the Wi-Fi Zone # in the STB BEFORE continuing with LG Smart Install. If the EZ-Manager is currently active, see “TV Configuration Options” on page 17 for further information. If the STB is currently in Pass-through Mode, see Reference section, “Using the STB’s Zoning Features,” for further information.**
3. To access the LG Smart Install utility Integrated USB Downloading screen from the STB menus:
 - Press **MENU** on the Installer Remote to display the STB setup menu (STB is in Pass-through Mode) or the Function Menu (STB is not in Pass-through Mode).
 - Use the arrow navigation keys to select/highlight either the **Option** menu icon from the STB setup menu or the **Lock** menu icon from the Function Menu. Then, press the number “7” key a total of seven times.

(Continued on next page)

LG Smart Install Utility (Cont.)

(Continued from previous page)

- The Integrated USB Downloading screen contains a listing of the files stored in the LGSMARTINSTALL folder on the USB device.

To select or de-select a file, respectively, use the Up/Down arrows on the Installer Remote to highlight the filename, and press **OK** to add or remove the checkmark at the left of the filename.

Note: The utility will only allow you to select one of each file type for downloading. For example, if there are two TLX files in the LGSMARTINSTALL folder, you can only select one or the other of those two files. By default, the first instance of each file type listed on the screen is selected.

Note: Use the arrow keys on the Installer Remote to select **Previous** and press **OK**, as necessary, to exit the LG Smart Install utility. If you accessed the utility via the EZ-Manager Wizard, you will be returned to the last screen on display before you inserted the USB device. If you accessed the utility via the STB menus, you will be returned to TV viewing.

- When you are ready to continue, use the arrow keys on the Installer Remote to select **Next**, and then press **OK**.

Download progress will be shown in a new screen. Do NOT remove the USB device until downloading is complete. When the download is complete, an overview of the results will briefly be displayed in a "Complete" screen and then you will either be returned to TV viewing or the STB will reboot (the latter if software has just been downloaded).

- Remove the USB memory device, and verify that the appropriate configuration is resident on the STB.

Note: (TLX configuration only) When configuration is complete, the STB tunes according to the Start Channel setting in the Installer Menu. If a Start Channel is specified, the STB will tune to that channel, though in the case of FTG Mode configuration, a channel banner will only be displayed if the Start Channel is included in the FTG Channel Map. Otherwise, the STB will either return to the last channel tuned (STB in Pass-through Mode) or tune to the first channel in the FTG Channel Map (STB in FTG Mode).

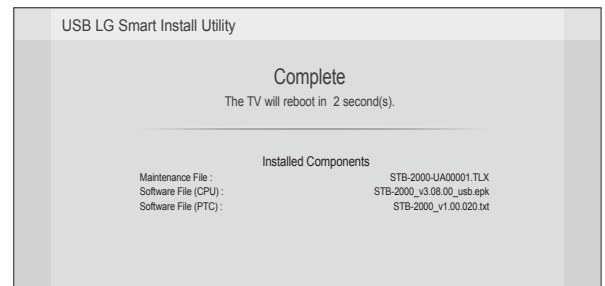
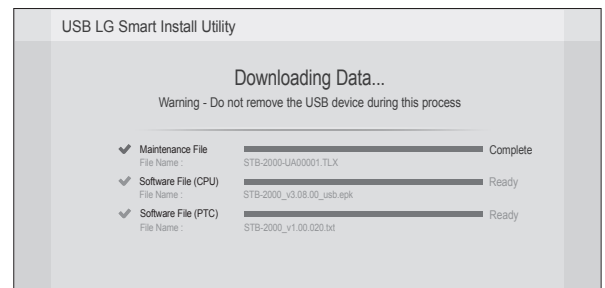
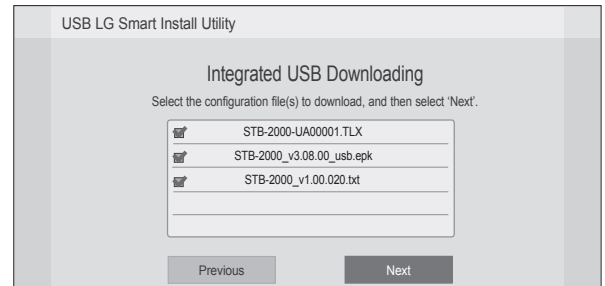

Use the Installer Menu to set up, change, or view operational settings. This section describes how to access, use, and exit the Installer Menu on location; however, you should also refer to the Installer Menu descriptions in this document if you are configuring the STB using an FTG Configuration (.tfx) file created using LG's FTG File Manager software.

Refer to the table on pages 27 and 28 for brief descriptions of Installer Menu items. More detailed descriptions follow the table listing.

Accessing the Installer Menu

1. Turn ON the STB/display panel.

If the EZ-Manager Wizard appears on the screen when you turn ON the STB/display, exit the wizard.

2. Using an Installer Remote, press **MENU** repeatedly until the on-screen display of the setup menus (if the STB is in Pass-through Mode) or the Function Menu (if the STB is not in Pass-through Mode) no longer toggles, and then press the STB Installer Menu entry sequence (e.g., **9-8-7-6**) + **EXIT** to access the STB Installer Menu.

Note: The default Installer Menu entry sequence is "9876"; however, if Installer Menu item 000 INSTALLER SEQUENCE has been modified, the entry sequence may be one of three additional options. See Installer Menu detailed descriptions for further information.

The Installer Menu opens with item 000 INSTALLER SEQ 000.

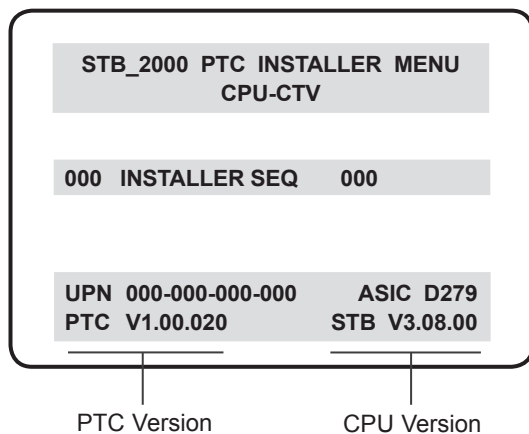

Typical Installer Menu

The menu header identifies this as the STB-2000 Installer Menu. In the Installer Menu footer, you can see the current software versions of the STB, as indicated.

Note: If the password (entry sequence) is not entered or registered correctly, you will see the message "ENTER STB PASSWORD 0000" at the top of the screen instead of the STB Installer Menu header. Once you re-enter the correct password (e.g., press 9-8-7-6 + EXIT), the STB Installer Menu will display.

Note: If an LG Hospitality TV (for example, LP645H, LT670H, etc.) is being used as the display panel (connected to DISPLAY CONTROL 2 on the STB) and you press the TV Installer Menu entry sequence + OK, you will access the TV's Installer Menu instead of the STB's Installer Menu. The TV's Installer Menu is accessible as read-only.

Note: If the STB is not in Pass-through Mode, the Installer Menu is accessible as read-only. Also, the TV Zone # will be indicated in the Installer Menu header under the configuration mode indicator described on the following page.

Installer Menu (Cont.)

As part of the Installer Menu header (in all modes), two 3-character acronyms are displayed to indicate the STB's current configuration mode. The table below lists all possible mode identifiers for the STB-2000.

Acronym	Description
CPU-CTV	Pass-through Mode with Channel Map in CPU
CPU-FTG	FTG Mode via CPU
CPU-P:C	Application Tuning Mode via CPU
MPI-EXT	External MPI Control
PTC-CTV	Pass-through Mode with Channel Map in PTC

Using the Installer Menu

Refer to the table starting on the next page for an overview of the available Installer Menu items, including their item numbers, functions, value ranges, and default values.

Installer Menu items not relevant to the STB are not present in the Installer Menu; therefore, some numbers are missing. For example, item 006 will not appear. In addition, items that are dependent on other Installer Menu item settings will not be initially accessible. For example, item 046 STRT AUX SRCE will not display in the Installer Menu unless item 004 STRT CHANNEL is set to 0. See Installer Menu detailed descriptions for further information.

Navigation within the Installer Menu

Use the Up/Down arrow keys on the Installer Remote to sequence through the available menu items, or access an item directly by keying in the item number and then pressing **MENU**. For example, to access the SLEEP TIMER option, which is item 015, press 0-1-5 + MENU.

Changing Installer Menu Settings

To change an Installer Menu item value, use the Left/Right arrow keys on the Installer Remote, or enter a valid value directly. To save the new setting, press **OK**, or use the Up/Down arrow keys to navigate to a new Installer Menu item if you have additional items to edit. Note that invalid values will not be saved.

Exiting the Installer Menu and Activating Settings

After you have adjusted all required Installer Menu item settings, press **OK** once on the Installer Remote to save your changes; then, press **OK** again to exit the Installer Menu. Any changes you make will be stored in non-volatile memory.

Note: Each time you exit the Installer Menu in Pass-through Mode, all V-Chip (Parental Control) settings in the STB are reset to their default values; that is, the Lock System, if previously enabled from the Lock setup menu, will now be disabled, and the individual Parental Control settings will be restored to default values.



Caution: Installer Menu settings may affect options available from the STB setup menus or the Function Menu.

Installer Menu (Cont.)

Installer Menu Items 000 through 071

Item	Function	Value Range	Default Value	Brief Description of Function
000	INSTALLER SEQ	0 ~ 3	0	Leave default set to 0.
001	POWER MANAGE	0 ~ 7	0	Sets number of hours of no activity before automatic shutoff.
002	AC ON	0 ~ 3	0	Set to 1 to enable STB/display panel to turn ON when AC power is applied. Set to 2 or 3 to enable Instant ON when AC power is applied. (See detailed descriptions.)
003	BAND/AFC	0 ~ 3	1	Selects Tuning Band: 0=Broadcast, 1=CATV, 2=HRC, 3=IRC
004	STRT CHANNEL	0 ~ 127, 253, 255	255	Channel tuned when STB/display panel is turned ON. (Set to 255 to tune to channel tuned before STB/display turned OFF.)
005	CHAN LOCK	0 / 1	0	If set to 1, cannot tune from current channel.
007	STRT VOLUME	0 ~ 63, 255	255	Volume level when STB/display panel is turned ON. (Set to 255 to use volume level before STB/display turned OFF.)
008	MIN VOLUME	0 ~ 63	0	Sets minimum allowable volume setting.
009	MAX VOLUME	0 ~ 63	63	Sets maximum allowable volume setting.
010	MUTE DISABLE	0 / 1	0	Set to 1 to disable Mute Function.
011	KEY DEFEAT	0 / 1	0	If set to 1, menu navigation buttons/functions on LG Hospitality and commercial non-LG display panels are not functional/available. N/A for LG Public Displays or LG Commercial Monitors.
015	SLEEP TIMER	0 / 1	1	Set to 1 to enable Sleep Timer.
016	EN. TIMER	0 / 1	0	Set to 1 to enable On/Off Timers.
017	ALARM	0 / 1	1	Set to 1 to enable Alarm.
020	FEATURE LEVEL	0, 16 ~ 24	0	Determines an additional IR code scheme to which the STB will respond.
021	V-CHIP	0 / 1	1	Set to 1 to enable V-Chip (Parental Control) functions.
022	MAX BLK HRS	0 ~ 99	12	Sets number of V-Chip blocking hours.
023	CAPTION LOCK	0 / 1	0	Set to 1 to retain caption setting set before STB/display panel turned OFF.
028	CH. OVERRIDE	0 / 1	1	If set to 0, user access to channel settings in the STB setup menus is restricted and users can only tune to channels that are included in the channel lineup.
029	OLD OCV	0 / 1	0	Set to 1 to remap the PTC's direct tune channels for Aux inputs from 13x to 9x.
030	ACK MASK	0 / 1	0	If set to 1, enables ACK feature of MPI.
031	POLL RATE	20 ~ 169	94	Selects poll rate for MPI.
032	TIMING PULSE	186 ~ 227	207	Sets baud rate for MPI.
035	HDMI1 ENABLE	0 ~ 2	1	Set to 0 to disable HDMI 1. Set to 1 (DTV Mode) or 2 (PC Mode), as applicable, to enable HDMI 1.
039	REAR AUX EN.	0 / 1	1	Set to 1 to enable display panel Video 1 input jack.
041	SIMPLINK EN	0 ~ 3	0	Determines the status of the SIMPLINK feature. (See detailed descriptions.)
042	AUTO INPUTS	0 ~ 255	0	Determines the Aux inputs for which auto-sensing is enabled. (See detailed descriptions.)
046	STRT AUX SRCE	1, 3, 5, 255	255	Sets the starting Aux source (if item 004 STRT CHANNEL is set to 0).
047	AUX STATUS	0 / 1	0	Set to 1 for MPI Aux source to be reported as a channel number instead of Channel 0.
053	DIS. CH-TIME	0 / 1	0	Set to 1 to disable the STB's Channel-Time display.
069	EN. CH-T COL.	0 / 1	1	Set to 1 to enable custom color for the STB's Channel-Time display.
070	FOR. CH-TIME	0 ~ 7	2	Chooses custom foreground color for the STB's Channel-Time display.
071	BCK. CH-TIME	0 ~ 7	2	Chooses custom background color for the STB's Channel-Time display.

Installer Menu (Cont.)

Installer Menu Items 073 through 122

Item	Function	Value Range	Default Value	Brief Description of Function
073	CH NOT AVBLE	0 / 1	0	If set to 1 and item 028 CH. OVERRIDE is set to 0, a "CHANNEL NOT AVAILABLE" message is displayed if user attempts to direct tune a channel that is not included in the channel lineup.
075	REVERT CH	0 / 1	0	If set to 1 and loss of MPI communication occurs, STB tunes to Start Channel.
078	UPN MSB	0 ~ 255	0	User programmable number, most significant byte.
079	UPN MSB-1	0 ~ 255	0	User programmable number, most significant byte - 1.
080	UPN MSB-2	0 ~ 255	0	User programmable number, most significant byte - 2.
081	UPN LSB	0 ~ 255	0	User programmable number, least significant byte.
082	CHKSM ERROR	0 / 1	1	Enforces rigid MPI checksum.
083	HANDSHK TIME	0 ~ 5	5	Relaxes MPI timing to be compatible with PC-based Windows-controlled systems.
084	PERMANENT BLK	0 / 1	0	Removes block hours setting for Parental Control and makes block permanent.
086	V. MUTE TIME	0 ~ 50	0	Use to extend the normal video mute time during channel change.
088	EN NOISE MUTE	0 / 1	1	(Analog channels only) If set to 1, audio is muted if no signal is present.
090	KEY LOCK	0 / 1	1	If set to 1, all LG Hospitality and commercial non-LG display panel button functions are locked. N/A for LG Public Displays or LG Commercial Monitors.
091	HDMI2 ENABLE	0 ~ 2	1	Set to 0 to disable HDMI 2. Set to 1 (DTV Mode) or 2 (PC Mode), as applicable, to enable HDMI 2.
094	SAP MENU EN	0 / 1	1	Set to 1 to enable SAP feature in Function Menu.
096	DEF. ASP. RATIO	0 ~ 4	2	Sets default aspect ratio at power up. See detailed descriptions and item 106.
097	AUDIO OUTPUT	0 / 9	9	Set as required in accordance with external audio equipment connected to the STB. (See detailed descriptions.)
098	PRO:CENTRIC	0 ~ 3	0	Set to 0 to disable Pro:Centric operation. Set to 1 for Flash Mode. Set to 2 for GEM (Java Application) Mode. Set to 3 for HTML Mode.
100	VIDEO INTERFAC	3 ~ 5	3	Selects HDMI connection for display panel: 3 = HDMI1, 4 = HDMI2, 5 = HDMI3
102	ATSC BAND	0 ~ 4	4	Selects ATSC band.
103	ATSC TUNE MODE	0 / 1	1	Set to 1 (default) for Physical Channel scan. Set to 0 for Virtual Channel scan.
104	START MINOR CH	0 ~ 255	0	Selects Minor Start Channel. Set to 0 for NTSC.
105	VID OUT FORMAT	1, 4, 5	1	Sets format for video output: 1 = 720p, 4 = 1080p, 5 = 1366 x 768
106	ASP RATIO LOCK	0 / 1	0	To retain set aspect ratio on power cycle, set to 1. Set to 0 for default ratio on power cycle.
108	PANEL COM	0 ~ 3	2	Sets display panel baud rate: 0 = 1200, 1 = 2400, 2 = 9600, 3 = 115200
110	PANEL DELAY	0 ~ 15	8	Sets the display panel communication delay time.
113	PANEL TYPE	0 ~ 4	4	Selects display panel type. (See detailed descriptions.)
116	VIDEO MUTE EN	0 / 1	0	(Analog channels only) If set to 1, video mutes (blank screen) when no signal is present.
117	FACT DEFAULT	0 / 1	0	Set to 1 to restore the factory default settings of all Installer Menu items.
119	DATA CHANNEL	0 ~ 135, 253, 255	255	Set to 0 to disable. Set from 1 to 135 to match the RF channel number used by the Pro:Centric server as its data channel. Set to 255 to use Auto Search to find the Pro:Centric RF channel. (See detailed descriptions.)
121	UPDATE TIME HR	0 ~ 23, 128	128	Sets the Wake For Update hour. The value "128" is displayed as "OFF." Directly entering 128 turns the Wake For Update feature OFF.
122	UPDATE TIME MN	0 ~ 59, 255	0	Sets the minute for Wake For Update. (See detailed descriptions.)

Detailed Descriptions of Installer Menu Items

000 - INSTALLER SEQUENCE

Specifies entry sequence to the Installer Menu.

0 = 9876 1 = 4321
2 = 1478 3 = 3698

001 - POWER MANAGE (Power Management)

Determines hours of no activity before automatic shutoff. The Power Management function is for saving energy. If set to 0, Power Management is Off. Settings range from 0 ~ 7, with 1 ~ 7 representing the hours that the unit will remain ON, unless there has been activity from either the control panel or remote control.

002 - AC ON (AC Power Switchable)

If set to 1, this allows the STB/display panel to turn ON when AC power is applied. Pressing the POWER button is not necessary. This is desirable if the STB is plugged into a switched AC outlet. Set to 2 or 3 to enable the Instant ON feature (see additional information below). Set to 0 (default) for standard STB/display turn ON/OFF operation.

The Instant ON feature allows the STB to turn ON when AC power is applied, while the display panel remains OFF. The STB retains its ON status, and the POWER button only toggles the display On and Off.

- If this item is set to 2, the STB will reboot to check for and download updates from the Pro:Centric server each time the display panel is turned OFF. This setting is not recommended if the STB will be configured with a resident application.
- If this item is set to 3, the STB will not reboot to check for and download updates each time the display panel is turned OFF. This setting is recommended if the STB will be configured with a resident application. In this mode, the check for and download of updates is under application control. Refer to your site-specific documentation for further information on configuring the STB with a resident application.

When this item is set to 2 or 3, the STB will reboot once every 24 hours and, if applicable (i.e., item 119 DATA CHANNEL is set), check for and download updates from the Pro:Centric server. The time at which this event occurs depends on the setting of item 121 UPDATE TIME HR. See item 121 description for further information. Once the update cycle is complete, the STB completes the reboot and resumes its ON state with the display panel OFF.

Note: If set to 1, the STB does not respond to ON/OFF commands from the remote, and the SLEEP TIMER is also nonfunctional.

003 - BAND/AFC (Band/Automatic Frequency Control)

There are four possible settings for this option:

0 = Broadcast 1 = CATV (default)
2 = HRC 3 = IRC

If some channels were not found by Auto Tuning (Channel Search), select the appropriate Band setting here, and add the channels using the Channel Edit option in the Channel Menu.

004 - STRT CHANNEL (Start Channel)

If active, this function allows you to determine the initial Major Start Channel number when the STB/display panel is turned ON. This feature is useful for an in-house information channel, since the STB/display would always select that channel when it is turned ON. If set to 255, the last channel tuned before the STB/display was turned OFF will be the channel tuned when the STB/display is turned ON again.

0 = Aux 127 = Map to Major CH 4
1 ~ 125 = Major Ch. # 253 = IP Start Channel
126 = Map to Major CH 3 255 = Last Channel

Note: For a digital Start Channel, always remember to set item 104 to the Minor Start Channel number.

Note: 126 and 127 are mapped only in SONIFI PPV Mode.

Note: The IP Start Channel shown above can only be set in the FTG File Manager, which is used to configure STB CPUs for FTG Mode. The same applies for the additional Major Channel number range of 128 ~ 135 in Physical tuning and 128 ~ 999 in Virtual tuning mode. This means that these values, if set, will only be visible in the read-only Installer Menu when the STB is in FTG Mode. The read-only display also will show additional information about the channel, for example, the IP address and port number, etc.

005 - CHAN LOCK (Channel Lock)

Channel Lock is ideal if the system must always be on the same channel. Changing channels with the Channel Up/Down or keypad numbers is impossible. Channel Lock is inactive if set to 0 (default).

Generally, this feature is used in connection with item 004 STRT CHANNEL where the Start Channel may, for example, be set to 3 or 4. If the Start Channel is 3, then the STB will remain locked on channel 3.

NOTE: For items 007, 008, and 009

For legacy reasons, the scale used is 0–63. The PTC software will translate this to the 0–100 scale used by the STB.

To translate an STB volume level to the Installer Menu value, use the following formula:

$$\text{Installer Value} = \frac{\text{STB Value} \times 63}{100}$$

Enter only the whole number (disregard fractions).

007 - STRT VOLUME (Start Volume)

This function allows the Installer to determine the initial volume level setting when the STB/display panel is turned ON. This feature is useful for an in-house information channel, since the STB/display will always select that volume level when it is turned ON. The range of values is 0 to 63, 255. If set to 255, the last volume level before the STB/display was turned OFF will be the current volume level when the STB/display is turned ON again.

Installer Menu (Cont.)

008 - MIN VOLUME (Minimum Volume)

This function determines the minimum volume level allowable with the Volume (VOL) Up/Down control. In this way, for example, someone cannot set the volume too low to hear. The value range is from 0 to 63. The factory default is 0, which provides the full range of volume control, if item 009 MAX VOLUME is set to 63. It is recommended to set the same value on every STB.

Note: The minimum volume level cannot have a value setting higher than the maximum volume level (described below).

009 - MAX VOLUME (Maximum Volume)

This function determines the maximum volume level allowable with the Volume (VOL) Up/Down control. In this way, for example, someone cannot set the volume level high enough to disturb others. The value range is 0 to 63, with 63 as the default, which gives the user the full range of volume control, if item 008 MIN VOLUME is set to 0. It is recommended to set the same value on every STB.

Note: The maximum volume level cannot have a value setting lower than the minimum volume level (described above).

010 - MUTE DISABLE

Enables or disables sound mute function. If set to 1, sound cannot be muted. If set to 0, sound can be muted.

011 - KEY DEFEAT

Applicable for LG Hospitality and commercial non-LG display panels only. If set to 1, Key Defeat is enabled, which means that end users cannot access or navigate within the STB's on-screen menu(s) using the display panel button(s); e.g., SETTINGS, OK, and menu navigation buttons will not function. Set to 0 to disable Key Defeat.

Note: Users can always access the STB's menus by pressing MENU on the remote.

Note: This feature does not apply to LG Public Displays or LG Commercial Monitors since the STB will always disable those displays' panel buttons and the processing of IR.

015 - SLEEP TIMER

If set to 1, the Sleep Timer feature may be used. If set to 0, the Sleep Timer is not available.

016 - EN. TIMER (Enable On/Off Timers)

If set to 1, the Timer function is available to the end user and enabled continuously. Set to 0 to disable On/Off timers.

Note: The STB clock must be set in order for timers to be used.

017 - ALARM

Gives the installer the option of making the Alarm function available to the end user. If set to 1, the Alarm function is available to the end user. Set to 0 to disable the Alarm function.

Note: The STB clock must be set before the Alarm function will work.

020 - FEATURE LEVEL

Determines an additional IR code scheme to which the STB will respond, allowing for the use of unique IR codes based on "bed number" in a multi-STB/display single room installation. First determine the IR mode; then select the bed number.

Values	IR Mode	Bed #
0	Disabled	N/A
16–24	Multi-code Remote	1–9

Note: The STB-dedicated Installer Remote is required for use of this feature. For further information, see Reference section, "STB Installer Remote."

021 - V-CHIP (Parental Control)

Set to 1 to activate V-Chip (Parental Control) and have it available to the end user to filter and control or otherwise restrict programming content that can appear. Set to 0 to turn the V-Chip feature Off (not available to user); no programming restrictions can be set.

022 - MAX BLK HRS (Maximum Block Hours)

Sets hours from 0 to 99 for the maximum V-Chip (Parental Control) block hours. Default setting is for 12 blocking hours.

Note: This item is not available in the Installer Menu when item 021 V-CHIP is set to 0 or when item 084 PERMANENT BLK is set to 1.

023 - CAPTION LOCK

If set to 0, captions are OFF when the STB/display panel is turned ON. Set to 1 to use the caption setting configured before the STB/display was turned OFF when the STB/display is turned ON.

028 - CH. OVERRIDE (Channel Override)

Applicable for Pass-through Mode only. If set to 1, users can select channels either with Channel Up/Down or by direct keypad entry. This setting also allows full access to channel settings in the STB setup menus (i.e., channels may be added or removed from the channel lineup, channel labels and icons may be edited, etc.). If set to 0, the channel lineup is locked. That is, user access to channel settings in the STB setup menus is restricted, and users can only tune to the channels that are included in the channel lineup. Also, in this case, if the channel lineup has not been transferred to the PTC (via 2-5-5 + MENU Mode, as described in the Master STB Setup procedure), users can only select channels using Channel Up/Down; direct keypad entry is not available.

029 - OLD OCV (On Command Video™)

Set to 1 to remap the PTC's direct tune channels for Aux inputs from 13x to 9x. This allows 2-digit only tuning systems (i.e., legacy OCV) to direct tune Aux inputs. See also Reference section, "STB Aux Input Configuration."

030 - ACK MASK

MPI Communication Parameter. When set to 1, enables ACK feature of MPI.

031 - POLL RATE

MPI Communication Parameter. Selects poll rate for MPI. Step size of 16 ms. Changing from default may affect communication via MPI.

032 - TIMING PULSE

MPI Communication Parameter. Sets baud rate for MPI. Step size of 4.3 uS. Changing from default may affect communication via MPI.

035 - HDMI1 ENABLE

Set to 1 to enable HDMI 1 input in DTV Mode. Set to 2 to enable HDMI 1 input in PC Mode. Set to 0 to disable display panel HDMI 1 input.

039 - REAR AUX EN. (Rear Aux Enable)

Set to 1 to enable display panel rear Aux (Video 1) input. Set to 0 to disable display panel rear Aux (Video 1) input.

041 - SIMPLINK EN

Set to 0 to disable the SIMPLINK feature. Set to 1 to enable SIMPLINK functionality without enabling remote control access to the SIMPLINK Menu. Set to 2 to enable both SIMPLINK functionality and SIMPLINK Menu access, though note that the Speaker menu option will be inaccessible/grayed out. Set to 3 to enable all aspects of SIMPLINK feature and SIMPLINK Menu. If a home theater device is connected to the STB, users can select either the TV (display panel) or HT (home theater) speaker.

Note: When both this item *and* item 042 AUTO INPUTS are enabled in the Installer Menu, HDMI inputs will be detected by SIMPLINK, but the Auto Input(s) Sensing Feature will not function.

042 - AUTO INPUTS

Determines the Aux inputs for which auto-sensing is enabled. Set to 0 to disable auto-sensing for all available inputs. Set to 255 to enable auto-sensing for all available inputs. For information on options for individual input settings, refer to Reference section, "Auto Input(s) Sensing Feature."

Note: In order for auto-sensing to be enabled for an input, that input must also be enabled in the Installer Menu. For example, to enable auto-sensing for HDMI 1, item 035 HDMI1 ENABLE must also be set to 1 or 2. Also, see note above regarding STB operation when both this item and item 041 SIMPLINK EN are enabled.

046 - STRT AUX SRCE (Start Aux Source)

Sets the starting Aux source. When turned ON, the STB/display panel will tune to starting Aux source if item 004 STRT CHANNEL is set to 0.

1 = Video 1 3 = HDMI 1
5 = HDMI 2 255 = Last Aux (default)

Note: Above is applicable only if all Aux sources are enabled.

Note: This item is not available in the Installer Menu unless item 004 STRT CHANNEL is set to 0.

047 - AUX STATUS

Set to 1 for MPI Aux source to be reported as a channel number instead of channel 0. Set to 0 to disable Aux identification change. Controls MPI status channel response for Aux inputs.

053 - DIS. CH-TIME (Disable Channel-Time)

Set to 1 to disable the STB's Channel-Time display; the STB's Channel-Time display will not appear. Set to 0 to enable the STB's Channel-Time display.

069 - EN. CH-T COL. (Enable Channel-Time Custom Color)

Set to 1 to enable custom color for the STB's Channel-Time display. Set to 0 to disable custom color for the Channel-Time display.

070 - FOR. CH-TIME (Channel-Time Display Foreground Color)

Set the STB's Channel-Time display foreground color according to the following color chart:

0 = Black	3 = Cyan	6 = Yellow
1 = Blue	4 = Red	7 = White
2 = Green	5 = Violet	

Note: If foreground color and background color are the same, the menu background will be transparent.

Note: Applies only to "Channel Not Available" message if item 073 CH NOT AVBLE is set to 1 (enabled). Also, items 070 FOR. CH-TIME and 071 BCK. CH-TIME are not available in the Installer Menu when item 069 EN. CH-T COL. is set to 0.

071 - BCK. CH-TIME (Channel-Time Display Background Color)

See description for item 070 FOR. CH-TIME above. The color chart is the same for both items.

073 - CH NOT AVBLE (Channel Not Available)

If set to 1 and item 028 CH. OVERRIDE is set to 0, a "CHANNEL NOT AVAILABLE" message is displayed when a user attempts to direct tune a channel that is not included in the channel lineup.

Note: This item is not available in the Installer Menu when item 028 CH. OVERRIDE is set to 1.

075 - REVERT CH (Revert to Start Channel)

If set to 1 and loss of MPI communication occurs, the STB automatically tunes to the specified Start Channel.

Note: This item is not available in the Installer Menu when item 004 STRT CHANNEL is set to 255.

078 - UPN MSB (UPN Most Significant Byte)

User programmable number, most significant byte readable by MPI command. Note: Not linked to serial number.

079 - UPN MSB-1 (UPN Most Significant Byte-1)

User programmable number, most significant byte-1 readable by MPI command. Note: Not linked to serial number.

Installer Menu (Cont.)

080 - UPN MSB-2 (UPN Most Significant Byte-2)

User programmable number, most significant byte-2 readable by MPI command. Note: Not linked to serial number.

081 - UPN LSB (UPN Least Significant Byte)

User programmable number, least significant byte readable by MPI command. Note: Not linked to serial number.

082 - CHKSM ERROR (Checksum Error)

Enforces rigid MPI checksum validation. Set to 1 for validation. Set to 0 to disable (does not check checksum on MPI async port). SPI is always checked.

083 - HANDSHK TIME (Handshake Time)

Adds an additional delay to the handshake time which is 64 msec, thus relaxing MPI timing requirements to be compatible with PC-based Windows controlled systems. Range is 0 - 5. (Timeout = 25.5MS + [25.5 MS* Handshake time].)

084 - PERMANENT BLK (Permanent Block)

Allows Lock (Parental Control) blocking schemes to be permanent by disabling the blocking hours function. Set to 1 to install Parental Control restrictions permanently. Set to 0 for user-specified hours control of blocking schemes.

Note: This item is not available in the Installer Menu when item 021 V-CHIP is set to 0.

086 - V. MUTE TIME (Video Mute Time)

Use to extend the normal video mute time during channel change. For example, you may wish to extend the normal video mute time to prevent the display of encrypted video (i.e., from a Pro:Idiom encrypted channel) that has not yet been decrypted. When set to 0, the normal video mute time is not extended. Set from 1 to 50 to increase the normal video mute time in 100 ms step increments up to a maximum of 5 seconds (e.g., the value of 25 represents 2.5 seconds, or 25 x 100 ms = 2.5 seconds).

088 - EN NOISE MUTE (Enable Noise Mute)

Applicable for analog channels only. If set to 1, audio mutes if no signal is present.

090 - KEY LOCK

Applicable for LG Hospitality and commercial non-LG display panels only. If set to 1, Key Lock is enabled, which means that all display panel button functions will be locked, i.e., non-functional. Set to 0 to disable Key Lock.

Note: This feature does not apply to LG Public Displays or LG Commercial Monitors since the STB will always disable those displays' panel buttons and the processing of IR.

091 - HDMI2 ENABLE

Set to 1 to enable HDMI 2 input in DTV Mode. Set to 2 to enable HDMI 2 input in PC Mode. Set to 0 to disable display panel HDMI 2 input.

094 - SAP MENU EN (2nd Audio Program)

Set to 1 to enable the SAP feature in the Function Menu, when the Function Menu is available (i.e., STB is not in Pass-through Mode). Set to 0 to disable the SAP feature in the Function Menu, when the Function Menu is available.

096 - DEF. ASP. RATIO (Default Aspect Ratio)

Selects default aspect ratio at power up:

0 = Set By System	1 = 4:3
2 = 16:9 (default)	3 = Just Scan
4 = Zoom	

Note: This item is not available in the Installer Menu unless item 106 ASP RATIO LOCK is set to 0.

097 - AUDIO OUTPUT

Determines availability of the analog audio output to be used by external audio equipment connected to the Audio Line Out jack on the STB. Set to 0 to disable audio output. Set to 9 (default) to enable fixed line level (typically 400 mVrms ± 100 mVrms @10KΩ) output. See also Reference section, "External Audio Line Out Specifications."

098 - PRO:CENTRIC

Selects the Pro:Centric Application Mode. Set to 0 (default) to disable the Pro:Centric application. Set to 1 for Flash Mode. Set to 2 for GEM (Java Application) Mode. Set to 3 for HTML Mode.

In order to retrieve the Pro:Centric application, when enabled (for Flash, GEM, or HTML Mode), the STB must be turned OFF/ON two times. Once you exit the Installer Menu, turn OFF the STB/display panel for at least one minute. When you turn the STB/display back ON, the STB will start the appropriate library based on the setting of this item. Wait until TV programming appears on the display, and then turn the STB/display back OFF, this time for a few minutes, to initiate the application download. When you turn the STB/display back ON, press the PORTAL key on the Installer Remote, and verify that the Pro:Centric application appears on the display.

Note: This item is not available in the Installer Menu when item 119 DATA CHANNEL is set to 0.

100 - VIDEO INTERFAC

Selects the HDMI port on the display panel to be used for HDMI input from the STB. Set to 3 for HDMI 1 (default). Set to 4 for HDMI 2. Set to 5 for HDMI 3.

If you change the value of this item, make sure to reconnect the HDMI cable from the STB to the appropriate HDMI port on the display panel once you have exited the Installer Menu.

102 - ATSC BAND

Sets up STB to receive different types of incoming signals.

0 = Broadcast	1 = CATV	2 = HRC
3 = IRC	4 = Same as NTSC	

103 - ATSC TUNE MODE

Sets ATSC tuning mode. Default set to 1 for Physical Channel scan. Set to 0 for Virtual Channel scan.

104 - START MINOR CHANNEL

Sets Minor Start Channel number at power up. 0 = NTSC. If not 0, number selected is the digital channel's Minor Start Channel number.

Note: This item is not available in the Installer Menu when item 004 STRT CHANNEL is set to 0 or 255.

105 - VID OUT FORMAT

Selects the format for video output (i.e., the screen resolution):

1 = 720p (default) 4 = 1080p 5 = 1366 x 768

If you change the video output format, once you exit the STB Installer Menu, the STB will reboot to change to the new video output resolution. When the reboot is complete, a confirmation pop-up window for the resolution will be displayed on the screen. See "Setting the Video Output Resolution" on page 14 for further information.

106 - ASP RATIO LOCK (Aspect Ratio Lock)

Set to 1 to retain previous aspect ratio with power off. Set to 0 to retain default aspect ratio with power off. See item 096 DEF. ASP. RATIO above.

108 - PANEL COM (Panel Communication)

Sets the display panel baud rate:

0 = 1200 1 = 2400
2 = 9600 (default) 3 = 115200

110 - PANEL DELAY

Sets the delay time in seconds before the STB initiates communication with the display panel after the STB/display is turned ON. 8 seconds is the default.

113 - PANEL TYPE

Selects the display panel type. This setting is only applicable for LG Public Display TVs and Commercial Monitors that use the DISPLAY CONTROL 1 port for STB-to-display panel communication. The default value (4) will be appropriate for most of these display types. See Reference section, "Display Panel Specifications," to determine the appropriate setting for the display panel being used.

116 - VIDEO MUTE EN (Video Mute Enable)

Applicable for analog channels only. If set to 1, video mutes (blank screen) when no signal is present.

117 - FACT DEFAULT (Factory Default)

Set to 1 and press OK to restore the factory default settings of all Installer Menu items. Once complete, the value returns to 0.



Caution: If set to 1, this clears all STB Installer Menu custom settings and restores the factory default settings. It also clears the channel lineup, including any assigned channel icons and custom text labels.

Note: See also Reference section, "Restoring Factory Defaults on the STB(s)," for further information.

119 - DATA CHANNEL

Set to 0 to disable. Set from 1 to 135 to match the RF channel number that will be used by the Pro:Centric server as its data channel. If left at the default value (255), the STB's Data Channel Auto Search feature will be enabled (see additional information below). *

Data Channel Auto Search feature: When this item is set to 255 (default), once every 24 hours, the STB will initiate a search of 10 predefined channels (10, 20, 30, ... 100) and then, if necessary, perform a complete search of the RF channels (1 to 135) in an attempt to find the RF channel used by the Pro:Centric server as its data channel. If the Pro:Centric RF channel is found, the DATA CHANNEL value will be changed from 255 to match the server's RF channel number. The time at which the Auto Search occurs depends on the setting of item 121 UPDATE TIME HR. See item 121 description for further information.

Note: Pro:Centric updates are downloaded from the Pro:Centric server to the STB when the STB/display panel is turned OFF. While Pro:Centric updates are in progress, it is not possible to turn ON the STB/display.

Note: The Data Channel is automatically set to "253" if Media Type is set to "IP" either in the EZ-Manager Wizard or in the STB's IP Environment / Pro:Centric Menu (see "EZ-Manager Wizard" on pages 15 to 22 or "Pro:Centric Setup" on pages 60 to 61, respectively) or if Installer Menu item #119 Data Channel is set to "IP Address" in the FTG File Manager, which is used to configure STB CPUs for FTG Mode operation. It is not possible to change the value to "253" directly in the Installer Menu.

* PCS150R and later Pro:Centric servers do not support HRC or IRC cable channel frequencies.

Installer Menu (Cont.)

121 - UPDATE TIME HR

Based on the settings of this item and item 122 UPDATE TIME MN, the Wake For Update feature wakes the STB once daily to check for and, if applicable, download updates from the Pro:Centric server.

Set the Wake For Update hour from 0 to 23. This item uses the 24-hour clock format. The value "128" (default) is displayed as "OFF." Directly entering 128 resets the default value (OFF) for this item, though note that this setting does not mean the STB will not initiate update events—see additional information below.

Under standard STB/display panel OFF/ON operating conditions (i.e., item 002 AC ON is set to 0), a Wake For Update event occurs when the STB/display is OFF and causes the STB to temporarily turn ON, perform the update cycle, and then turn back OFF, all while the display remains OFF. If item 002 AC ON is set to 2 or 3 for Instant ON, then the STB is always ON and Wake For Update occurs when the display is OFF. The Wake for Update event causes the STB to reboot in order to perform the update cycle and then return to its ON state with the display panel OFF. See also description for item 002.

Random Distribution of Update Time: If this item is set to 128 (OFF), the time at which either a Data Channel Auto Search (item 119 set to 255) and/or an Instant ON update (item 002 set to 2 or 3) occurs is determined as follows: The STB will initiate the search and/or check for updates during the 2 AM hour (if the STB clock is set) or after two hours of elapsed time from when AC power was applied (if the STB clock is not set). The update time minute is randomly distributed per STB during the hard-coded hour. That is, each individual STB is assigned a fixed update time minute from 0 to 59. (In installations with a large quantity of STBs, there will be some STBs that have the same update minute assignments.) The update time/assigned update minute for the STB is displayed at the right of this item in the Installer Menu, for example:

121 UPDATE TIME HR OFF 02:34

If the display is ON when a Wake For Update is to occur, the update will take place the next time the display is turned OFF.

Note: This item is not available in the Installer Menu when item 119 DATA CHANNEL is set to 0, except when item 002 AC ON is set to 2 for Instant ON.

Note: The STB clock must be set in order for a Wake For Update event to occur at the precise time of day in accordance with item 121 and item 122 settings.

122 - UPDATE TIME MN

Set the Wake For Update minute from 0 to 59. If item 121 is NOT set to 128 and you wish to invoke the "random" minute assignment on the STB, set this item to 255. See also description for item 121 UPDATE TIME HR above.

Note: This item is not available in the Installer Menu unless item 121 UPDATE TIME HR is set from 0 to 23.

Note: The STB clock must be set in order for a Wake For Update event to occur at the precise time of day in accordance with item 121 and item 122 settings.

This section describes how to create a customized Master STB Setup for cloning purposes when the STB is in Pass-through Mode.

Note: Cloning requirements and procedures are described in detail on pages 40 to 44. Refer to FTG Mode information on pages 45 to 51 for details on entering FTG Mode and configuring/editing the FTG Channel Map and FTG Installer Menu settings.

Before You Begin

- It is recommended that you disconnect all Aux inputs if you intend to run Auto Tuning (Channel Search). Under certain conditions, Auto Tuning is disabled if there is an Aux input active.
- All Learning and Teaching processes on the STB are performed via USB memory device. See “Cloning Methods” below to determine the type of file—either the TLX file format or the legacy TLL file format—to use for cloning purposes; several of the Master STB Setup procedure steps are dependent on the desired file type.

Cloning Methods

See also “Clonable STB Setup Menu Features” list below.

Using a USB Memory Device / TLX File

- The TLX file format clones Installer Menu settings, IP Environment Menu settings (with the exception of unique STB attributes), and all STB sources’ (analog, digital, AV1, HDMI, etc.) clonable setup menu settings.
- Not intended for cloning an auto-tuned/edited channel lineup, as the channel lineup is converted to a logical FTG Channel Map when saved (Learned) from an STB to a TLX file. If the TLX file with the FTG Channel Map is then used for Teaching purposes, the Target STB(s) will be configured for FTG Mode.

Using a USB Memory Device / TLL File

The TLL file format only clones the contents of the commercial controller (PTC) memory, which is limited to an auto-tuned/edited channel lineup, Installer Menu settings, and one STB source’s (analog, digital, or Aux) clonable setup menu settings.

Clonable STB Setup Menu Features

Channel Auto Tuning (Channel Lineup) Manual Tuning Channel Edit Channel Label	Audio AV Sync * Sound Setting	Option Language Caption Pointer *
Picture Aspect Ratio	Time Clock Mode (Auto/Manual) * Time Zone Auto Off	

* AV Sync, DST (Clock Mode), and Pointer settings are cloned via TLX file only.

Note: Some menu options vary between analog and digital channels and Aux inputs.

Custom Master STB Setup (Cont.)

Custom Master STB Setup Procedure

1. Turn ON the STB/display panel.

The next step depends on whether the EZ-Manager Wizard appears on the screen when you turn ON the STB/display:

- If the wizard is displayed, the STB is in the required factory default state. Exit the wizard, and then continue with step 2.
- If the wizard is not displayed, restore the STB to a factory default condition before continuing with this procedure. See Reference section, "Restoring Factory Defaults on the STB(s)," as necessary, for further information.

2. Set Installer Menu items.

This step provides specific instruction only on the Installer Menu items that should be set on a Master STB. Refer to pages 25 to 34 for detailed information on all Installer Menu items.

- a) Use the Installer Remote to access the PTC Installer Menu (see "Accessing the Installer Menu" on page 25 for further information).
- b) Set Installer Menu item **003 BAND/ AFC**, as appropriate.
 - Broadcast: Set to 0.
 - CATV: Set to 1 (default).
 - HRC: Set to 2.
 - IRC: Set to 3.
- c) Set any other Installer Menu items that affect your TV programming network to the required configuration. For example, set the panel display type (if applicable), enable/disable Aux inputs, set a Start Channel, etc.

If you intend to use a TLX file for cloning purposes, you may also configure selected settings in the IP Environment Menu (accessible from the Installer Menu). See "IP Environment Setup" on pages 56 to 63 for further information. In particular, if you intend to use the Wi-Fi Zoning feature, you must configure the wireless network connection as part of the Master STB Setup. However, note that you cannot return directly to the Installer Menu from the IP Environment Menu; thus, you may wish to set all Installer Menu items as needed before you access the IP Environment Menu. Otherwise, you will need to reaccess the Installer Menu to set additional items.

- d) After you have adjusted all Installer Menu item settings as required, press **OK** once on the Installer Remote to save your changes; then, press **OK** again to exit the menu.

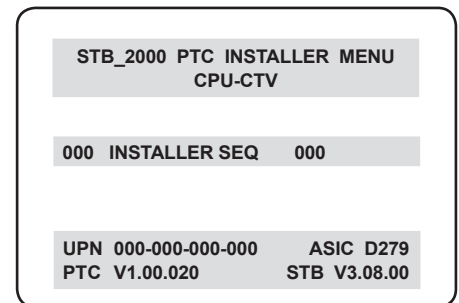

Typical Installer Menu

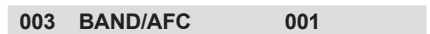

Adjust the value for this Installer Menu item, as required.

(Continued on next page)

(Continued from previous page)

3. Set up STB/display panel features.

On-screen setup menus control the features of the STB/display. Press **MENU** on the Installer Remote to access the STB setup menus, and then set Channel, Picture, Audio, Time, etc. options to the desired configurations. See “Clonable STB Setup Menu Features” list on page 35 and also notes below.

Note: If you intend to use a TLX file for cloning purposes, and you wish to use the Zoning feature(s) on this STB, make sure to assign the appropriate TV Zone # and/or Wi-Fi Zone # at this time as described in Reference section, “Using the STB’s Zoning Features.”

Note: If you intend to clone the PTC, remember that only one STB source’s clonable setup menu settings will be cloned. Thus, the setup menu settings should be applicable to the analog or digital channel or Aux input to which the Target STB will be set during Teaching.

Note: If desired and if appropriate depending on the cloning method to be used (see “Cloning Methods” on page 35), you can run Auto Tuning (see step 4) prior to completing this step.

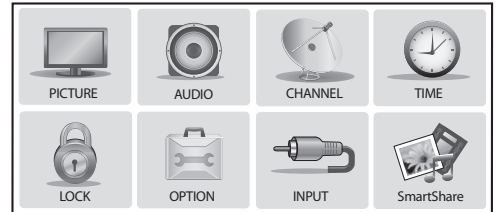

Use the STB setup menus to set the display features to the desired configuration for the end user.



Note: The next three steps (4 to 6) are applicable for PTC cloning only (i.e., cloning using a TLL file). If you intend to use a TLX file for cloning purposes, proceed directly to step 7 to verify the STB setup.

4. (PTC cloning only / Optional) Run Auto Tuning.

Note: If you run Auto Tuning with the intention to clone the resulting channel lineup and the Target STB(s) is/are to remain in Pass-through Mode, you MUST use a TLL file for this cloning purpose.

- Use the Installer Remote to access the Channel Menu. Then, select **Auto Tuning** and follow the on-screen instructions to search for all available analog and digital channels.
- Use the **Channel Edit** option in the Channel Menu to edit the channel lineup, as necessary. Add/delete channels per your system requirements.
- Use the **Channel Label** option in the Channel Menu to select the appropriate trademark/icon for each channel’s Channel-Time on-screen display. Icons are available for familiar channels, such as ABC, CBS, NBC, etc. Identifiable labels (icons) should enable the end user to readily know what common networks are available.

Note: If Installer Menu item 103 ATSC TUNE MODE is set for Physical Channel tuning (default and recommended setting), channels with minor channel numbers higher than 255 will not transfer correctly in step 5. If item 103 is set for Virtual Channel tuning and either the major or minor channel numbers are higher than 255, the channel(s) will not transfer correctly in step 5.

Note: You can add the channel icons in this step or as described in step 6. Also in step 6, you can add custom text labels for channels without icons.

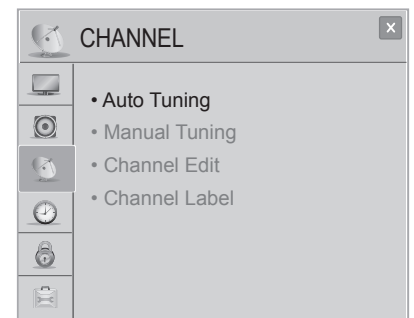

(Optional) Use Channel Menu options to run Auto Tuning, edit channels, and select channel icons.

Custom Master STB Setup (Cont.)

(Continued from previous page)

5. (PTC cloning only) Transfer the auto-tuned/edited channel lineup (if applicable) and setup menu settings to the PTC: 2-5-5 + MENU Mode



Note: This step is essential for successful cloning using a TLL file. Without this step, the PTC will not contain any channels or setup menu settings.



Note: The maximum number of channels (analog and digital) that can be transferred to the PTC is 141. An attempt to transfer more than 141 channels of any combination will result in a PTC Channel Map of exactly 141 channels; any extra channels will not be available in the PTC Channel Map.

- a) After the STB channel lineup has been edited and channel label icons added, tune to the channel (source) for which you wish to transfer the setup menu settings.
- b) Access the Installer Menu, and press **2-5-5 + MENU** on the Installer Remote to initiate the transfer of the Master STB Setup to the PTC. The STB exits the Installer Menu and then tunes through the channels in the channel lineup during the transfer. When the transfer is complete, the STB tunes back to the channel that was tuned before the transfer began.

6. (PTC cloning only / Optional) Add Custom Channel and Aux Input Labels: 2-5-4 + MENU Mode

2-5-4 + MENU Mode enables you to add/edit channel icons and custom text labels in the PTC Channel Map once the Master STB Setup has been transferred as described in the previous step.

Access the Installer Menu, and press **2-5-4 + MENU** on the Installer Remote. Add/edit custom text labels and/or change icons for the Channel-Time on-screen displays (see 2-5-4 + MENU procedural information on page 39). Note that broadcast digital channels often already have a broadcaster generated label. When you are finished, press **MENU** to exit 2-5-4 + MENU Mode.

7. Verify the STB/display panel setup.

Make sure the STB/display features are set per your requirements. Also, if cloning an auto-tuned/edited channel lineup, verify that the channel lineup, channel icons, and custom text labels (as applicable) are correct.

8. (Recommended) Lock the channel lineup.

Access the Installer Menu. Set item **028 CH. OVERRIDE** to **0** and press **OK** to lock the channel lineup and restrict access to the STB setup menus. This step prevents end users from accessing channel settings (i.e., the Channel Menu will be inaccessible/grayed out). Press **OK** again to save your changes and exit the Installer Menu.

The Master STB Setup is now ready to be saved to a USB memory device (TLX or TLL file). See "Cloning Procedures" on pages 40 to 44.

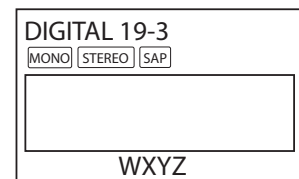

Custom text label "WXYZ" created in 2-5-4 + MENU Mode.

028 CH. OVERRIDE 000

After verifying the STB Setup, it is recommended that you set Installer Menu item 028 CH. OVERRIDE to 0.

Channel Icons / Custom Text Labels (2-5-4 + MENU Mode)

Changing Channel Icons and/or Adding or Editing Custom Text Labels in the Channel-Time Display

If there is no pre-assigned icon for a channel, you can add a custom text label of up to seven (7) characters to help identify the channel or network. Also, if desired, a custom text label can be added to the Channel-Time display in addition to a pre-assigned icon. You may also add text labels for the Aux input sources to clearly identify the devices that are connected to the Aux inputs.

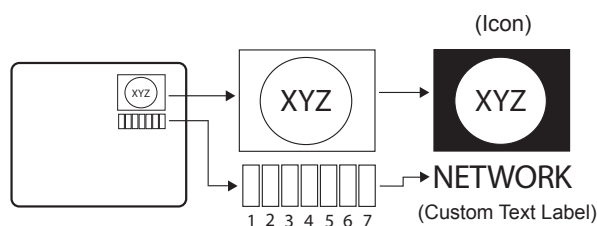

Changing icons and/or adding or editing custom text labels can only be done if there are channels that have been transferred to the STB's PTC either during Master STB Setup (see pages 35 to 38) or by cloning (TLL file only). **Note:** A blank letter space is available between "Z" and "!".

To perform channel editing/labeling:

1. Access the Installer Menu (see "Accessing the Installer Menu" on page 25 for further information).
2. Press **2-5-4 + MENU** on the Installer Remote to access the Channel Label Editing Menu.
3. Change channel icons and/or add or edit custom text labels as described in the procedures below. (You can do this more than once.)
4. To exit the menu when done, press **MENU**.

Changing a Channel's Icon on the Master STB

1. Use Channel Up/Down to select the desired channel.
2. Use the Left/Right arrow keys to select the thin letter "I" on the Channel-Time display.
3. Use the Up/Down arrow keys to select the icon with which you want to identify the channel. (If you know the icon number, enter the number, and press **OK**.)
4. Proceed to add/edit custom text labels, or go to the next channel.

Adding/Editing Channel Labels on the Master STB

1. Use Channel Up/Down to select the desired channel.
2. Press the Left or Right arrow repeatedly until the numbers 1 to 7 appear on the display. The number shows the position of the character that can be changed. Number 1 is the first character, number 2 the second character, etc.
3. Use the Up/Down arrow keys to select the desired character.
4. Proceed to the next number position, or go to the next channel.

Adding/Editing Source Labels on the Master STB

1. Press **INPUT** to select the desired Aux input source: AV, HDMI, or HDMI2.
2. Press the Left or Right arrow repeatedly until the numbers 0 to 9 appear on the display. The number shows the position of the character that can be changed.
3. Use the Up/Down arrow keys to select the desired character.
4. Press **INPUT** for the next Aux input, or use Channel Up/Down to return to channels.

Installer Remote Control Key Functions for Master STB Channel Label Editing Menu

- **Channel Up/Down:** Tunes to the next channel in scan.
- **Left/Right Arrows:** Select the item to change. If "I" is shown, the icon can be changed. If a number is shown, it indicates the position of the character that can be changed.
- **Up/Down Arrows:** Select the icon or the character to be displayed. Tip: Arrows can be held down for fast scrolling.
- **0 – 9:** Use to enter the index number of the icon, if known.
- **OK:** Changes the icon after the icon number has been entered.
- **INPUT:** Changes the Aux input label.
- **MENU:** Exits the editing process.

Cloning Procedures

Cloning Overview

Cloning refers to the process of capturing a Master STB Setup and transferring it to a Target STB that is to remain in Pass-through Mode. There are two different procedures for cloning a Master STB Setup, each with its own advantages and limitations (see also “Cloning Methods” on page 35):

- Using a USB memory device / TLX file
- Using a USB memory device / TLL file

Each cloning method is described in further detail on the pages that follow.

Learning / Teaching a Master STB Setup using a TLX File

This section describes how to Learn and/or Teach a Master STB Setup using a TLX file.

Before You Begin

- Learning and Teaching is only possible between identical model STBs.
- Complete the Custom Master STB Setup procedure (see pages 35 to 38).
- Ensure the USB device has been formatted with FAT format.
- If you would like the Target STB(s) to remain in Pass-through Mode after Teaching, ensure the Master STB Setup does not have an auto-tuned/edited channel lineup; otherwise, Teaching will result in the Target STB(s) being configured for FTG Mode.
- If a TV Zone # and/or a Wi-Fi Zone # has/have been set in the Master STB (for location-specific configuration) before the Learning process is initiated, the Zone designation(s) will be used during the subsequent Teaching process(es). This means that in order for the “Learned” clone data with TV Zone and/or Wi-Fi Zone assignments to be applied, any Target STBs will need to be assigned the same Zone designation(s) BEFORE Teaching is performed. See Reference section, “Using the STB’s Zoning Features,” for further information. See also bullet below.
- If you intend to use the Zoning feature(s) on this STB, make sure to assign the appropriate TV Zone # and/or Wi-Fi Zoning # as described in Reference section, “Using the STB’s Zoning Features,” BEFORE continuing with the Learning procedure below. See also bullet above. For the Wi-Fi Zoning feature, the Master STB’s wireless network connection settings also should be configured in the IP Environment Menu before Learning is initiated.
- It is not possible to clone a Master STB’s clock. Either set a Target STB’s clock manually, or use the Auto Clock setting in the STB setup menus.



Caution: Do not unplug the STB power cord or remove/disconnect the USB memory device while Learning or Teaching, as doing so may cause the STB to malfunction or harm the USB device, respectively.

Learn Setup from Master STB

1. Ensure the Master STB is set up completely and in Pass-through Mode (i.e., the STB setup menus should be displayed on the screen when you press **MENU** on the Installer Remote).
2. Insert the USB memory device into either of the USB ports on the Master STB.
3. Press **MENU** on the Installer Remote to display the STB setup menus. Use the arrow navigation keys to select/highlight the **Option** menu icon, and then press the number “7” key a total of seven times to display the USB Download Menu.
4. To gain access to the “Learn From STB” options in the USB Download Menu, key in the following number sequence on the Installer Remote: **9-8-7-6**.
5. Use the Up/Down arrow keys to select **Learn From STB (TLX)**, and then press **OK**.
6. In the Learn From STB (TLX) window, to differentiate this TLX file from others, you can use the Up/Down arrow keys to change the last five digits of the filename. Press **OK** when you are ready to initiate Learning.
Learning status will be shown on a progress bar in a new window. Do NOT remove the USB device until Learning is complete. When the Learning process is complete, the USB Download menu will reappear on the screen.
7. When Learning is done, press ↵ on the Installer Remote to exit the USB Download Menu, and remove the USB memory device from the Master STB.

Teach Master STB Setup to Target STB

1. Turn ON the Target STB/display panel.
2. The next step depends on whether the EZ-Manager Wizard appears on the screen when you turn ON the STB/display:
 - If the wizard is displayed, the STB is in the required factory default state. To continue with this procedure (see also note below), exit the wizard, and then continue with step 3.
 - If the wizard is not displayed, restore the STB to a factory default condition before continuing with this procedure. See Reference section, “Restoring Factory Defaults on the STB(s),” as necessary, for further information.

Note: If desired, you can complete the Teaching process via the EZ-Manager Wizard (see “USB Configuration” on page 22) or using the LG Smart Install utility (see “LG Smart Install Utility” on pages 23 to 24).

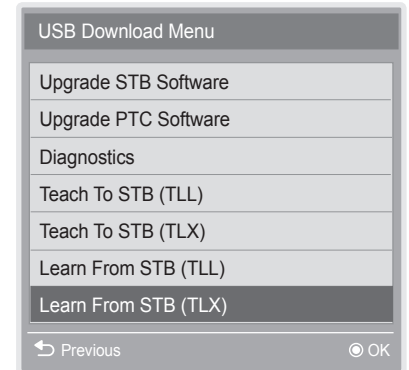

Note: The Diagnostics option in this menu is for service use only.

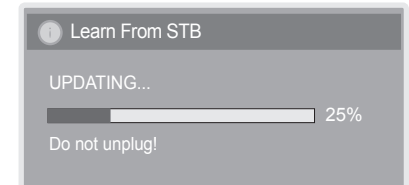
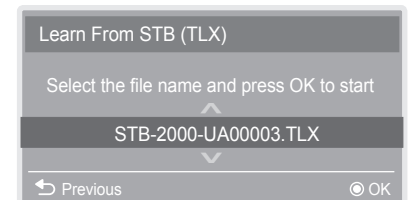

(Continued on next page)

Cloning Procedures (Cont.)

(Continued from previous page)

3. If the Master STB Setup contains a TV Zone # and/or a Wi-Fi Zone # assignment, make sure to assign the same Zone designation(s) in the Target STB at this time. See Reference section, "Using the STB's Zoning Features," for further information.



Note: In order for the proper location-specific TV Zone and/or Wi-Fi Zone profile data to be applied, the Zone designation(s) must be assigned in the Target STB(s) BEFORE Teaching is performed.

4. Insert the USB memory device with the TLX file into either of the USB ports on the Target STB.
5. Press **MENU** on the Installer Remote to display the STB setup menus. Use the arrow navigation keys to select/highlight the **Option** menu icon, and then press the number "7" key a total of seven times to display the USB Download Menu.
6. With the USB Download Menu on display, use the Up/Down arrow keys to select **Teach To STB (TLX)**, and then press **OK**.
7. In the Teach To STB (TLX) window, use the Up/Down arrow keys to select the Master STB Setup you want to install.

Note: Filenames for TLX files Learned from an STB are comprised of the STB model and a five-digit number, for example, STB-2000-UA00003.TLX.

8. Press **OK** when you are ready to initiate the Teaching process.
Teaching status will be shown on a progress bar in a new window. Do NOT remove the USB device until Teaching is complete. When the Teaching process is complete, a "Teaching Completed" window will briefly appear on the screen and the USB Download Menu will be exited.
9. Remove the USB memory device, and verify that the Master STB Setup is now resident on the Target STB.

After the Teaching process is complete, the STB tunes according to the setting of Installer Menu item 004 STRT CHANNEL (Start Channel). If a Start Channel is specified, the STB will tune to that channel; otherwise, the STB will return to the last channel tuned.

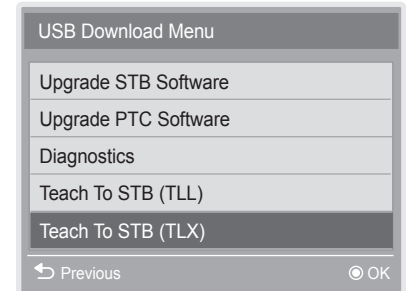

Note: The Diagnostics option in this menu is for service use only.

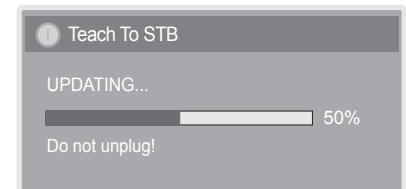
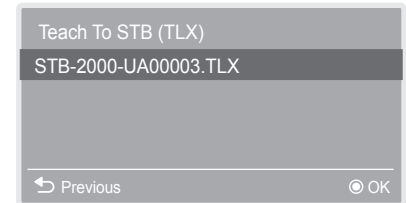

Learning / Teaching a Master STB Setup using a TLL File

This section describes how to Learn and/or Teach a Master STB Setup using a TLL file.

Before You Begin

- Learning and Teaching is only possible between identical model STBs.
- Complete the Custom Master STB Setup procedure (see pages 35 to 38).
- Ensure the USB device has been formatted with FAT format.
- You may edit the filename as part of the Learning procedure; however, a file with edited contents will not be recognized.
- It is not possible to clone a Master STB's clock. Either set a Target STB's clock manually, or use the Auto Clock setting in the STB setup menus.

 **Caution: Do not unplug the STB power cord or remove/disconnect the USB memory device while Learning or Teaching, as doing so may cause the STB to malfunction or harm the USB device, respectively.**

Learn Setup from Master STB

1. Ensure the Master STB is set up completely and in Pass-through Mode (i.e., the STB setup menus should be displayed on the screen when you press **MENU** on the Installer Remote).
2. Insert the USB memory device into either of the USB ports on the Master STB.
3. Press **MENU** on the Installer Remote to display the STB setup menus. Use the arrow navigation keys to select/highlight the **Option** menu icon, and then press the number "7" key a total of seven times to display the USB Download Menu.
4. To gain access to the "Learn From STB" options in the USB Download Menu, key in the following number sequence on the Installer Remote: **9-8-7-6**.
5. Use the Up/Down arrow keys to select **Learn From STB (TLL)**, and then press **OK**.
6. In the Learn From STB (TLL) window, to differentiate this TLL file from others, you can use the Up/Down arrow keys to change the last five digits of the filename. Press **OK** when you are ready to initiate Learning.

Learning status will be shown on a progress bar in a new window. Do NOT remove the USB device until Learning is complete. When the Learning process is complete, the USB Download Menu will reappear on the screen.

7. When Learning is done, press **↵** on the Installer Remote to exit the USB Download Menu, and remove the USB memory device from the Master STB.

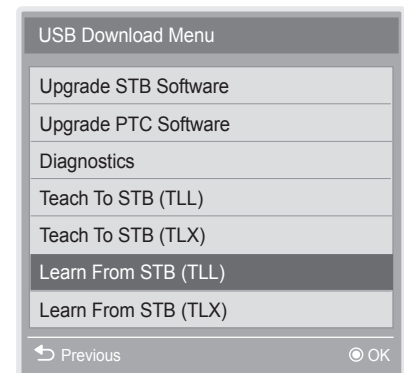

Note: The Diagnostics option in this menu is for service use only.

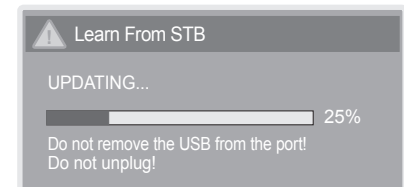
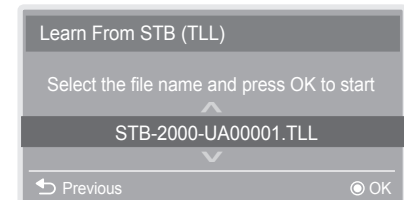

Cloning Procedures (Cont.)

Teach Master STB Setup to Target STB

1. Turn ON the Target STB/display panel.
 2. The next step depends on whether the EZ-Manager Wizard appears on the screen when you turn ON the STB/display:
 - If the wizard is displayed, the STB is in the required factory default state. To continue with this procedure (see also note below), exit the wizard, and then continue with step 3.
 - If the wizard is not displayed, restore the STB to a factory default condition before continuing with this procedure. See Reference section, “Restoring Factory Defaults on the STB(s),” as necessary, for further information.
- Note:** If desired, you can complete the Teaching process via the EZ-Manager Wizard (see “USB Configuration” on page 22).
3. Tune/set the STB to an analog or digital channel or Aux input (ideally the same source tuned for 2-5-5 + MENU Mode during the Master STB Setup procedure).
 4. Insert the USB memory device with the TLL file into either of the USB ports on the Target STB.
 5. Press **MENU** on the Installer Remote to display the STB setup menus. Use the arrow navigation keys to select/highlight the **Option** menu icon, and then press the number “7” key a total of seven times to display the USB Download Menu.
 6. With the USB Download Menu on display, use the Up/Down arrow keys to select **Teach To STB (TLL)**, and then press **OK**.
 7. In the Teach To STB (TLL) window, use the Up/Down arrow keys to select the Master STB Setup you want to install.
- Note:** Filenames for TLL files Learned from an STB are comprised of the STB model and a five-digit number, for example, STB-2000-UA00001.TLL.
8. Press **OK** when you are ready to initiate the Teaching process.

Teaching status will be shown on a progress bar in a new window. Do NOT remove the USB device until Teaching is complete. When the Teaching process is complete, the USB Download menu will reappear on the screen.
 9. When Teaching is done, press **↵** on the Installer Remote to exit the USB Download Menu, remove the USB memory device from the STB, and turn OFF the STB/display.
 10. After a few seconds, turn ON the STB/display, and verify that the Master STB Setup is now resident on the Target STB.

When you turn it back ON, the STB will tune according to the setting of Installer Menu item 004 STRT CHANNEL (Start Channel). If a Start Channel is specified, the STB will tune to that channel; otherwise, the STB will return to the last channel tuned.

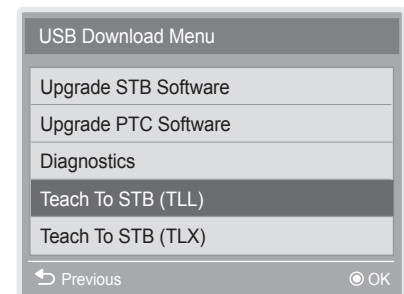

Note: The Diagnostics option in this menu is for service use only.

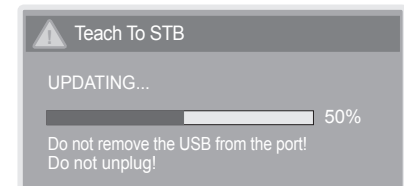
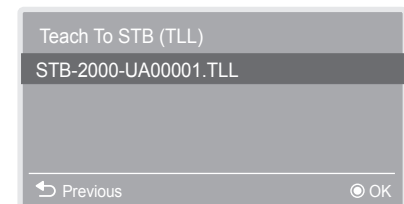

This section describes how to create an FTG Configuration (.tlx) file using the FTG File Manager. It also describes how to locally configure an STB for FTG Mode operation. See also the FTG Mode overview on pages 10 to 11 for further information on FTG Mode.

Creating an FTG Configuration File

This procedure below describes how to use the FTG File Manager utilities to create an FTG Configuration (.tlx) file that can be saved to a USB memory device. In order to enable decryption of Pro:Idiom encrypted channels, it is recommended that you create or view/edit an FTG Configuration file using the FTG File Manager. FTG File Manager software is available online at: www.LGolutions.com/ftgsoftware.

Note: There is also an option to save (Learn) FTG Configuration from an STB, which may be desirable or required if you want to save customized STB setup menu settings to the FTG Configuration file and/or if you do not know the RF channels at the site. See “Learning FTG Configuration from an STB” on pages 49 to 50 for further information.

This procedure provides an overview of the steps required to create the FTG Configuration (.tlx) file. Refer to the *Free-To-Guest (FTG) File Manager User Guide* for further information. See also FTG File Manager sample screens on pages 52 to 55.

1. Install (if necessary) and launch the FTG File Manager (v1.1.8 or higher) on the PC that will be used to create the FTG Configuration (.tlx) file.
2. You have a number of options:
 - To view and/or base a new FTG Configuration file on an existing FTG Configuration (.tlx) file, click the **Open** button in the TLX File command section of the FTG File Manager main screen, and select/double-click on the desired “.tlx” file.

A list of the file’s contents will be displayed in the TLX File Contents window. Either double-click on an individual item to copy it or click the **Copy All** button directly above the TLX File Contents window to automatically copy all the contents of the opened file to the FTG Configuration List and, if applicable, TV Setup Menu List. Note, though, that while setup menu settings can be included in the new FTG Configuration file, the setup menu settings are not available for editing.

Edit the configuration of the items in the FTG Configuration List as well as the FTG Configuration List itself and/or the TV Setup Menu List, as necessary, to create a new file. Then, proceed to step 3 when you are ready to continue.

- To open an existing FTG Configuration (.rml) file created in the FTG Device Configuration Application to use its FTG Channel Map and/or FTG Installer Menu settings, click **File** and then **Open** from the FTG File Manager menu bar, and select/double-click on the desired “.rml” file.
Edit channels and/or settings as necessary. Then, proceed to step 3 when you are ready to continue.
- Create a new FTG Channel Map using the FTG Channel Map Editor in the FTG Channel Map Configuration Utility. Up to 600 logical channels (combined total of both RF and IP mapped channels) can be defined in the FTG Channel Map.

When you are ready to continue, click **Configure** and then **FTG File Manager** from the FTG File Manager menu bar to return to the FTG File Manager main screen, and then proceed to step 3.

Note: To remove an individual item from the FTG Configuration List or the TV Setup Menu List, click on/highlight the item to be removed, and then click the **Remove Item** button directly above the applicable “List” window. To clear both the current FTG Configuration List and TV Setup Menu List contents, click the **Clear** button in the List command section of the FTG File Manager main screen.

(Continued on next page)

FTG Mode of Operation (Cont.)

(Continued from previous page)

Note: To clear the current TLX File Contents, click the **New** button in the TLX File command section of the FTG File Manager main screen (above the TLX File Contents window).

3. To add an FTG Channel Map to the FTG Configuration List, click **>>** under FTG Channel Map. This will copy the current mapped RF and IP channels to the FTG Configuration List.

Note: If you make any change(s) in the FTG Channel Map Configuration Utility to the current data to be included in the FTG Configuration List, you will need to recopy the FTG Channel Map to the FTG Configuration List.

4. (Optional) Load default FTG Installer Menu settings for the STB:

- Click the down arrow at the right of the Chassis field in the Installer Menu Templates section of the FTG File Manager main screen, and select **STB-2000** from the drop-down list of available models.
- Click the **Load** button.
- Use the FTG Installer Menu Configuration Utility to modify settings, if necessary, including Media Share settings, Wi-Fi Zoning settings, etc. Then, return to the FTG File Manager main screen.

5. If you wish to change the Zone assignment for the current FTG Installer Menu settings, click on the down arrow at the right of the Zone field (below the FTG Installer Menu Settings field), and select the appropriate Zone (0–8).

Note: See Reference section, “Using the STB’s Zoning Features,” for further information on the TV Zoning feature and setting the TV Zone # in the STB(s).

6. To add FTG Installer Menu settings to the FTG Configuration List, click **>>** under FTG Installer Menu Settings. This will copy the selected model settings to the FTG Configuration List.

Note: If you make any change(s) in the FTG Installer Menu Configuration Utility to the current data to be included in the FTG Configuration List, you will need to recopy the FTG Installer Menu settings to the FTG Configuration List.

Note: At the top of both the FTG Configuration List and TV Setup Menu List windows, an Edit Zone field enables you to change the Zone assignment for each STB Installer Menu and/or TV Setup Menu profile, if desired. Select/highlight the desired profile, and then click on the down arrow at the right of the applicable Edit Zone field to select the appropriate Zone.

7. Click the **Save** button in the List command section of the FTG File Manager main screen to save the FTG Configuration List and, if present, TV Setup Menu List contents to an FTG Configuration (.tlx) file on the PC’s hard drive for later use.

In the Save As pop-up window, name the file, and click **Save**. The default folder path is C:\Program Files\Zenith\FTG\TLX. Note that the FTG Configuration file will have a “.tlx” file extension.

Note: To remove an individual item from the FTG Configuration List or the TV Setup Menu List before saving the new file, click on/highlight the item to be removed, and then click the **Remove Item** button directly above the applicable window. To clear both the current FTG Configuration List and TV Setup Menu List contents, click the **Clear** button in the List command section of the FTG File Manager main screen.

8. Transfer the FTG Configuration (.tlx) file to a USB memory device, and proceed to “Teaching FTG Configuration to an STB” on the following page to transfer the FTG Configuration file to an STB-2000.

Teaching FTG Configuration to an STB

This section describes how to transfer (Teach) an FTG Configuration file from a USB memory device to an STB using the USB Download Menu “Teach To STB (TLX)” option. The FTG Configuration file may be created either in the FTG File Manager or from a Master STB Setup that was saved (Learned) from a Master STB. Refer to “Creating an FTG Configuration File” on pages 45 to 46 for information on creating an FTG Configuration file using the FTG File Manager.

Before You Begin

- Ensure the USB device has been formatted with FAT format.
- If the EZ-Manager Wizard appears on the screen when you turn ON the Target STB/display, you can use the wizard’s “USB Configuration” option to access the USB Download Menu and complete the Teaching process (see “TV Configuration Options” and/or “USB Configuration” on pages 17 and 22, respectively, as necessary).
- You may also use the LG Smart Install utility to complete the Teaching process. See “LG Smart Install Utility” on pages 23 to 24 for further information.
- If the Target STB is currently in Pass-through Mode and you intend to use the STB’s Zoning feature(s)—i.e., the FTG Configuration file you are Teaching contains an FTG Channel Map and/or FTG profile(s) with TV Zone and/or Wi-Fi Zone assignments—make sure to assign the appropriate TV Zone # and/or Wi-Fi Zone # in the STB when directed to do so in the procedure below. See Reference section, “Using the STB’s Zoning Features,” for further information.
- If the FTG Configuration file contains an FTG Channel Map that was created in the FTG File Manager, each logical channel number in the FTG Channel Map has been assigned a physical RF channel or an Aux input (the latter designated by 130-0 through 137-0—see also Reference section, “STB Aux Input Configuration”). If the FTG Configuration file contains an FTG Channel Map that was Learned from an STB, the physical RF channels in the FTG Channel Map have been assigned logical channel numbers (see “Learning FTG Configuration from an STB” on pages 49 to 50).
- If the FTG Configuration file was created in the FTG File Manager, it may contain multiple zoned FTG Installer Menu profiles for different STB/TV models. Make sure it includes the appropriate Installer Menu profile(s) for the Target STB(s) before Teaching.



Caution: Do not unplug the STB power cord or remove/disconnect the USB memory device while Teaching, as doing so may cause the STB to malfunction or harm the USB device, respectively.

Teach FTG Configuration to Target STB

1. Turn ON the Target STB/display panel.
2. The next step depends on whether the EZ-Manager Wizard appears on the screen when you turn ON the STB/display:
 - If the wizard is displayed, you can complete the Teaching process via the wizard, as indicated above. However, to continue with this procedure and access the “Teach to STB (TLX)” option from the STB menus, exit the wizard. Then, continue with step 3.
 - If the wizard is not displayed, go directly to step 3.

(Continued on next page)

FTG Mode of Operation (Cont.)

(Continued from previous page)

3. If applicable (see also “Before You Begin” on previous page), make sure to assign the appropriate Zone designation(s) in the Target STB at this time.



Note: In order for the proper location-specific TV Zone and/or Wi-Fi Zone profile data to be applied, the Zone designation(s) must be assigned in the Target STB(s) BEFORE Teaching is performed.

4. Insert the USB memory device that contains the FTG Configuration file into either of the STB’s USB ports.
5. Press **MENU** on the Installer Remote to display the STB setup menus (STB is in Pass-through Mode) or the Function Menu (STB is already in FTG Mode).
6. Use the arrow navigation keys to select/highlight either the **Option** menu icon from the STB setup menus or the **Lock** menu icon from the Function Menu. Then, press the number “7” key a total of seven times to display the USB Download Menu.
7. With the USB Download Menu on display, use the Up/Down arrow keys to select **Teach To STB (TLX)**, and then press **OK**.
8. In the Teach To STB (TLX) window, use the Up/Down arrow keys to select the FTG Configuration file you want to install,
Note: Filenames for TLX files Learned from an STB are comprised of the STB model and a five-digit number, for example, STB-2000-UA00005.TLX.
9. Press **OK** when you are ready to initiate the Teaching process.
Teaching status will be shown on a progress bar in a new window. Do NOT remove the USB device until Teaching is complete. When the Teaching process is complete, a “Teaching Completed” window will briefly appear on the screen and then the STB will tune according to the the Start Channel setting in the Installer Menu (see below).
10. Remove the USB memory device from the Target STB, and verify that the FTG Configuration is resident on the STB.

Note: If it was previously in Pass-through Mode, the Target STB CPU is now in FTG Mode.

After the Teaching process is complete, the STB tunes according to the Start Channel setting in the Installer Menu. If a Start Channel is specified, the STB will tune to that channel, though a channel banner will only be displayed if the Start Channel is included in the FTG Channel Map; otherwise, the STB will tune to the first channel in the FTG Channel Map.

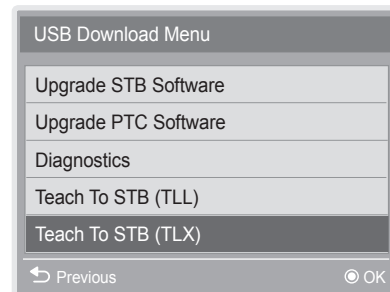

Note: The Diagnostics option in this menu is for service use only.

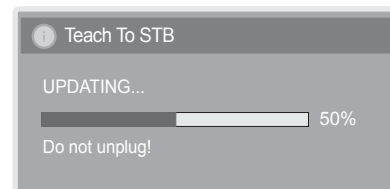
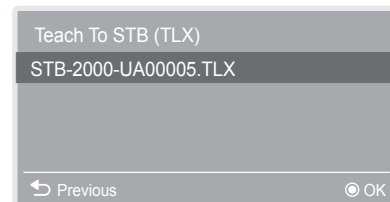

Learning FTG Configuration from an STB

To ensure that decryption of Pro:Idiom encrypted channels is enabled, it is recommended that you create an FTG Configuration file using the FTG File Manager as described on pages 45 to 46. However, if necessary, there is an option to save (Learn) an FTG Configuration file from an STB to a USB memory device.

The option to save (Learn) an FTG Configuration file from an STB may be desirable or required in either or both of the following situations:

- If you want to save customized STB setup menu settings to the FTG Configuration file, in addition to the FTG Channel Map and FTG Installer Menu settings.
- If you do not know the RF channels at the site, and you would like to use the STB to search for the available RF channels.

Before You Begin

- Ensure the USB device has been formatted with FAT format.
- If the STB is NOT already in FTG Mode, you may need to perform some manual configuration on the STB before you start this procedure (see “Optional Manual Configuration / STB Setup” on next page).
- If you intend to use the STB’s Zoning feature(s), make sure to assign the appropriate TV Zone # and/or Wi-Fi Zone # as described in Reference section, “Using the STB’s Zoning Features,” BEFORE continuing with the procedure below. Also, for Wi-Fi Zoning in particular, the STB’s wireless network connection settings should be configured in the IP Environment Menu before Learning is initiated.

 **Caution: Do not unplug the STB power cord or remove/disconnect the USB memory device while Learning, as doing so may cause the STB to malfunction or harm the USB device, respectively.**

Learn FTG Configuration from Master STB

1. Turn ON the Master STB/display panel, and then insert a USB memory device into either of the USB ports on the STB.
2. Press **MENU** on the Installer Remote to display the STB setup menus (STB is in Pass-through Mode) or the Function Menu (STB is already in FTG Mode).
3. Use the arrow navigation keys to select/highlight either the **Option** menu icon from the STB setup menus or the **Lock** menu icon from the Function Menu. Then, press the number “7” key a total of seven times to display the USB Download Menu.
4. To gain access to the “Learn From STB” options in the USB Download Menu, key in the following number sequence on the Installer Remote: **9-8-7-6**.

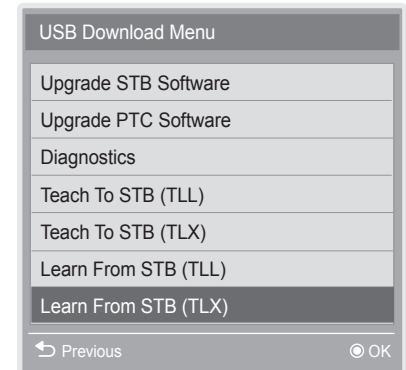

Note: The Diagnostics option in this menu is for service use only.

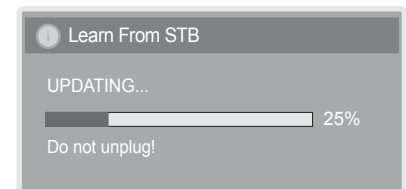
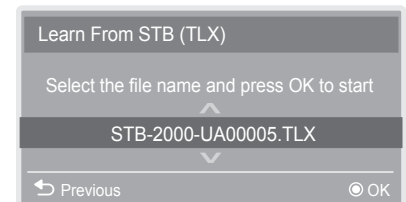

(Continued on next page)

FTG Mode of Operation (Cont.)

(Continued from previous page)

5. Use the Up/Down arrow keys to select **Learn From STB (TLX)**, and then press **OK**.
6. In the Learn From STB (TLX) window, to differentiate this TLX file from others, you can use the Up/Down arrow keys to change the last five digits of the filename. Press **OK** when you are ready to initiate Learning.
Learning status will be shown on a progress bar in a new window. Do NOT remove the USB device until Learning is complete. When the Learning process is complete, the USB Download Menu will reappear on the screen.
7. When Learning is done, press **↵** on the Installer Remote to exit the USB Download Menu, and remove the USB memory device.



Note: If the Master STB has a channel lineup, during Learning, logical channel numbers are automatically assigned in ascending order, starting with 0 (zero), to the physical RF channels of the STB channel lineup. See also note below.



Note: It is highly recommended that you open this FTG Configuration file in the FTG File Manager—BEFORE Teaching the file to any Target STBs—to verify FTG Channel Map and FTG Installer Menu settings and enable decryption by marking Pro:Idiom encrypted channels. This will also enable you to confirm channels and add channel attributes, labels, etc.

Optional Manual Configuration / STB Setup

The manual configuration procedures below should only be performed if you want to save customized STB setup menu settings to the FTG Configuration file and/or if you do not know the RF channels at the site and need to “Learn” FTG Configuration from an STB as described above.

Note: These configuration procedures parallel the initial steps required for creating a Master STB Setup. See also screen examples on pages 36 to 37.

Set Installer Menu Items

These steps provide specific instruction only on the Installer Menu items that should be set on an STB-2000. Refer to pages 25 to 34 for detailed information on all Installer Menu items.

1. Turn ON the STB/display panel.
2. The next step depends on whether the EZ-Manager Wizard appears on the screen when you turn ON the STB/display:
 - If the wizard is displayed, the STB is in the required factory default state. Exit the wizard, and then continue with step 3.
 - If the wizard is not displayed, restore the STB to a factory default condition before continuing with this procedure. See Reference section, “Restoring Factory Defaults on the STB(s),” as necessary, for further information.
3. Use the Installer Remote to access the PTC Installer Menu (see “Accessing the Installer Menu” on page 25 for further information).

(Continued on next page)

(Continued from previous page)

4. Set Installer Menu item **003 BAND/AFC**, as appropriate.
 - Broadcast: Set to 0.
 - HRC: Set to 2.
 - CATV: Set to 1 (default).
 - IRC: Set to 3.
5. Set any other Installer Menu items that affect your TV programming network to the required configuration. For example, enable/disable Aux inputs, set a Start Channel, etc.

You may also configure any required settings in the IP Environment Menu (accessible from the Installer Menu), for example wireless network connection settings, Pro:Centric IP settings, etc. See "IP Environment Setup" on pages 56 to 63 for further information. However, note that you cannot return directly to the Installer Menu from the IP Environment Menu; thus, you may wish to set all Installer Menu items as needed before you access the IP Environment Menu. Otherwise, you will need to reaccess the Installer Menu to set additional items.

6. After you have adjusted all Installer Menu item settings as required, press **OK** once on the Installer Remote to save your changes; then, press **OK** again to exit the menu.

Set Up STB Features

On-screen setup menus control the features of the STB/display. Press **MENU** on the Installer Remote to access the STB setup menus, and set Channel, Picture, Audio, Time, etc. options to the desired configurations. In particular, if you intend to use the STB's Zoning feature(s), make sure to assign the appropriate TV Zone # and/or Wi-Fi Zone # as described in Reference section, "Using the STB's Zoning Features."

Run Auto Tuning (Channel Search)

Note: Decryption of Pro:Idiom encrypted channels will not be enabled unless you use the FTG File Manager to set the channel attributes.

1. Use the Installer Remote to access the Channel Menu. Then, select **Auto Tuning** and follow the on-screen instructions to search for all available analog and digital channels.
2. Use the **Channel Edit** option in the Channel Menu to edit the channel lineup, as necessary. Add/delete channels per your system requirements.

Once you have completed these procedures, return to "Learning FTG Configuration from an STB" on the previous page to complete the Learn sequence.

FTG File Manager Utilities Overview

FTG File Manager Main Screen

The FTG File Manager main screen enables you to compile, modify, and save FTG Configuration (.tlx) files. It also allows you to change the Zone assignment for each Installer Menu profile, if desired (see Reference section, "Using the STB's Zoning Features," for further information).

The screenshot shows the FTG File Manager interface with the following callouts:

- FTG CONFIGURATION LIST**: Data to be saved in FTG Configuration (.tlx) file.
- CLEAR/SAVE**: FTG Configuration and TV Setup Menu List options.
- NEW/OPEN**: TLX File options.
- Filename of opened FTG Configuration (.rml) file created using FTG Device Configuration Application.**: Points to the 'FTG File:' text box.
- Copy FTG Channel Map to and from FTG Configuration List.**: Points to the 'FTG Channel Map' section.
- Copy FTG Installer Menu settings to and from FTG Configuration List. Assign Zone as applicable.**: Points to the 'FTG Installer Menu Settings' section.
- Load default FTG Installer Menu for STB-2000.**: Points to the 'Installer Menu Templates' section.
- TV SETUP MENU LIST**: STB Setup Menu data to be saved in FTG Configuration file.
- TLX FILE CONTENTS**: Data contained in opened FTG Configuration (.tlx) file.



Note: The data referenced in the FTG Configuration List is only a snapshot of the current FTG Channel Map and FTG Installer Menu settings when copied to the list. If you make any change(s) to the current data to be included in the FTG Configuration List, you will need to recopy Channel Map and Installer Menu settings to the FTG Configuration List.

FTG File Manager Utilities Overview (Cont.)

FTG Channel Map Editor

The FTG Channel Map Editor shows a single Logical Channel's data and the FTG Channel Map.

LOGICAL CHANNEL MAPPING

Select a Logical Channel number. Then, assign the RF, Major, and Minor channel numbers to complete the mapping.

CUSTOM CHANNEL LABELS/ICONS

Enter custom labels and select icons by name on menu or by number.

SET CHANNEL ATTRIBUTES

Check/select Encrypted, OSD, or Blank Video.

Logical	RF	Major	Minor	Label	ICON	Attribute	Restricted
2	2	2	0	WBBM-TV	14 - CBS	O	
5	5	5	0	WMAQ-TV	15 - NBC	O	
7	7	7	0	WLS-TV	13 - ABC	O	
9	9	9	0	WGN-TV	89 - WGN	O	
11	11	11	0	WTTW	17 - PBS	O	
14	31	31	3	FOX	16 - FOX	O	
15	19	19	3	WGN	89 - WGN	O	
16	47	47	4	KIDS	133 - PBS Kids	O	
17	27	27	3	THE U	174 - UPN	O	
40	65	65	1	HBO-HD	12 - HBO	EO	
41	65	65	11	ESPN-HD	2 - ESPN	EO	
42	67	67	1	ESPN2HD	21 - ESPN2	EO	

ZONE RESTRICTION

Set Zone restriction(s) per channel. See Reference section, "Using the STB's Zoning Features," for further information.

ADD

After defining a new Logical Channel, click to add channel to the FTG Channel Map.

EXIT

Click to exit editor and return to FTG Channel Map Configuration Utility.

UPDATE

After editing an existing Logical Channel's data, click to commit the changes in the FTG Channel Map.

DELETE

Click to remove highlighted channel from FTG Channel Map.

FTG Installer Menu Configuration Utility

CONFIGURATION SETTINGS

Select tabs for categories of Installer Menu items to set up STB.

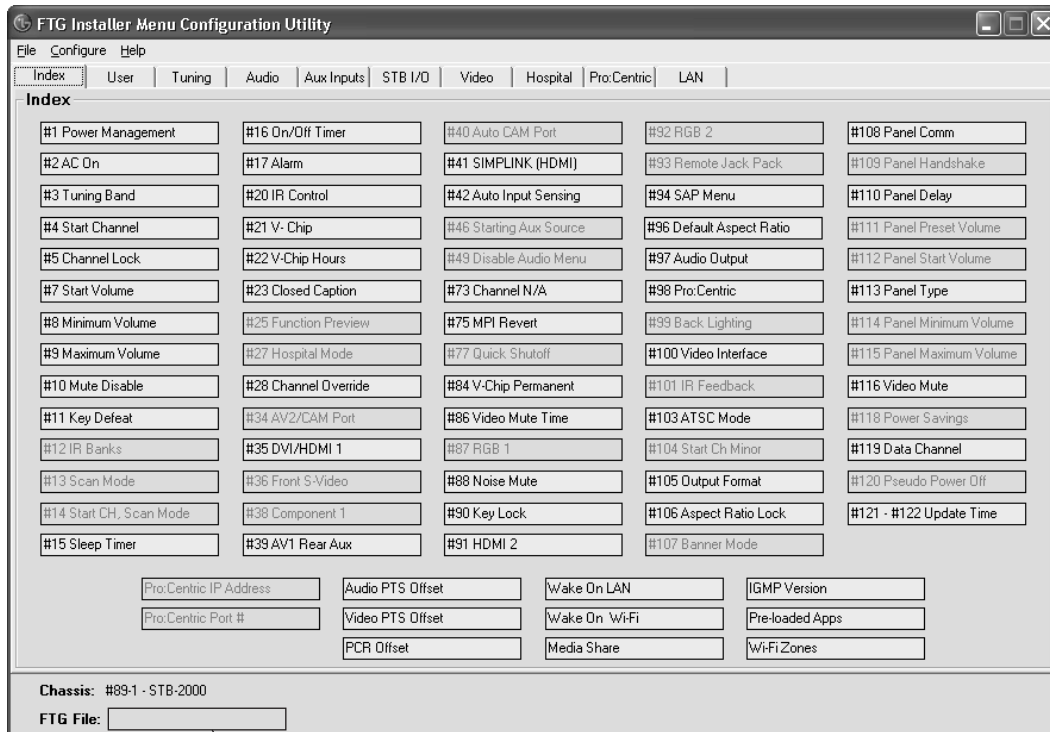

Filename of opened FTG Configuration (.rml) file created using FTG Device Configuration Application.

Notes:

- The STB I/O tab enables you to set up selected display panel video parameters; the Pro:Centric tab enables you to set up Pro:Centric-specific parameters; and the LAN tab enables you to set up a variety of LAN features, including the Wi-Fi Zoning feature. Refer to the **Free-To-Guest (FTG) File Manager User Guide** for further information. Also, see Reference section, “Using the STB’s Zoning Features,” for additional information on Wi-Fi Zoning.
- Hospital parameters are not applicable for the STB-2000.

IP Environment Setup

The IP Environment Menu enables you to set up the network features of the STB. With the exception of Network Connection settings, the IP Environment settings are editable (with the Installer Remote) only if the STB is in Pass-through Mode and read-only when the STB is not in Pass-through Mode. Also, if you intend to create a Master STB Setup for cloning purposes (using a TLX file—see Master STB Setup procedure on pages 35 to 38), all IP Environment settings, with the exception of Wired Network Connection settings and the STB name (editable in the Media Share Menu), may be cloned.

Accessing the IP Environment Menu

1. Use the Installer Remote to access the Installer Menu (see “Accessing the Installer Menu” on page 25 for further information).
2. Navigate to Installer Menu item 119 DATA CHANNEL, and press **2-5-3 + MENU** to launch the IP Environment Menu (see example at right).

Use the Up/Down arrow keys on the Installer Remote to select the desired menu option and then press **OK**. Refer to the following sections for information on each of the IP Environment setup options.

When you have completed your IP Environment configuration as required, press **EXIT** or **↵** on the Installer Remote to exit the IP Environment Menu.

Configuring the Network Connection

This option launches a Network Connection wizard that guides you through the process of setting up the STB’s wired and/or wireless network connection. Use the arrow keys on the Installer Remote to navigate between options.

Note: If desired, you can configure both wired and wireless connections. However, note that a wired connection is always prioritized over a wireless connection. That is, when the STB is turned OFF and then back ON, if a LAN cable is detected between the STB and the network, the STB will default to the wired connection. If the LAN cable is removed, the STB will then attempt to establish the wireless connection. Whenever the LAN cable is reconnected, the STB will re-establish the wired connection.

1. If you will use a wired network connection, connect the appropriate cable between the STB and the network.
2. With the IP Environment Menu on display, use the arrow keys on the Installer Remote to select **Network Connection**. Then, press **OK**.
3. In the first Network Connection wizard window, use the arrow keys to select the type of network—Wired or Wireless—to configure. Then, press **OK**.
4. Refer to the appropriate subsection below to complete the network connection configuration.

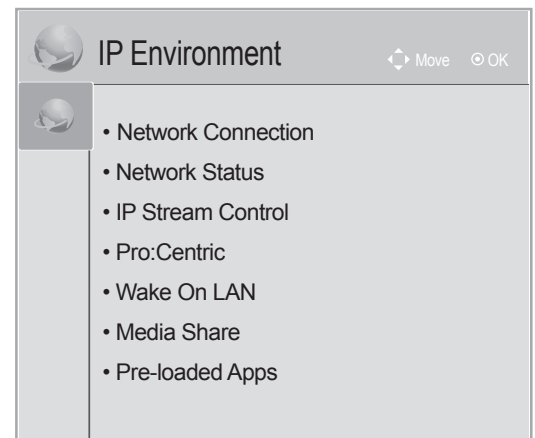

Note: When you enter the IP Environment Menu, the Installer Menu is exited. If you are also in the process of updating Installer Menu items, you may wish to set all items as needed before you access the IP Environment Menu. Otherwise, you will need to reaccess the Installer Menu to set additional items.

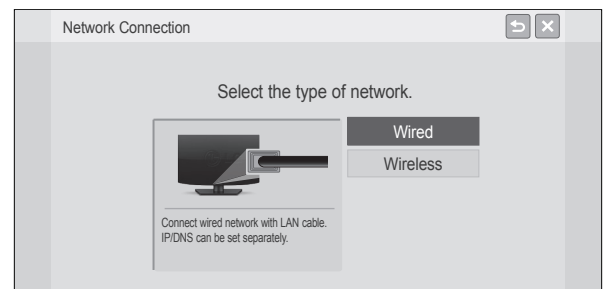

Wired Network Connection

1. The next Network Connection window will enable you to specify the IP and DNS configuration for this STB. Auto (DHCP) tabs will be selected by default. If a DHCP server is configured and a static configuration is not required, you can simply select **OK** (on the screen) and then press **OK** on the Installer Remote. The DHCP server will assign an IP address and DNS server to the STB once the STB successfully connects to the network.

Otherwise, use the arrow keys to select the Static tab(s), and specify the static configuration data for both the IP and DNS modes. When all fields are completed, select **OK** (on the screen) and press **OK** on the Installer Remote.

Note: You can specify a static DNS server with an auto-configured IP address but not vice versa.

The STB will attempt to connect to the network and you will see a progress screen that indicates status as each network element is confirmed (see example at right). If the network is connected successfully, a “Wired network is connected” message will be displayed at the top of the screen and the network configuration data will be displayed in the lower half of the screen.

2. Select **Complete** (if not already selected), and then press **OK** on the Installer Remote to exit the Network Connection wizard and return to the IP Environment Menu.

Note: If the network connection is not successful, the progress screen will identify the network element in which the connection failed. Check your cabling and/or, if necessary, press **↶** on the Installer Remote to return to the Configure IP and DNS Modes screen to verify the configuration data.

Wireless Network Connection

Note: If you intend to use the Wi-Fi Zoning feature with cloning configuration, you must configure the wireless network connection as part of the Master STB Setup.

1. In the next Network Connection window, use the arrow keys on the Installer Remote to select the type of wireless connection to configure and press **OK**.
 - AP List: Select from a list of available access points.
 - Enter the SSID: Direct enter the SSID of an access point whose SSID has not been enabled for broadcast (i.e., the access point does not appear in the AP List).
 - WPS-PBC: Connect to a network via an access point that is enabled for PBC.
 - WPS-PIN: Complete network/PIN verification via the access point web interface.
 - Ad-hoc: Connect to a network via a Wi-Fi device, such as a PC, mobile phone, etc.

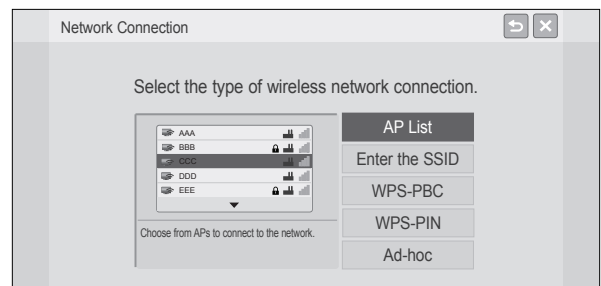
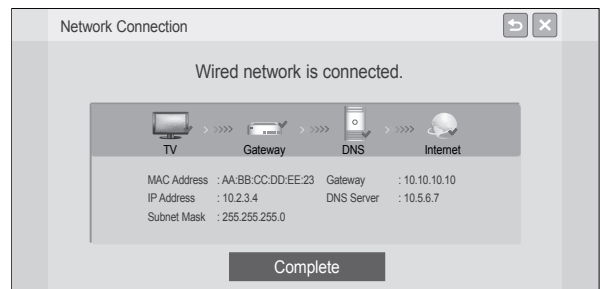
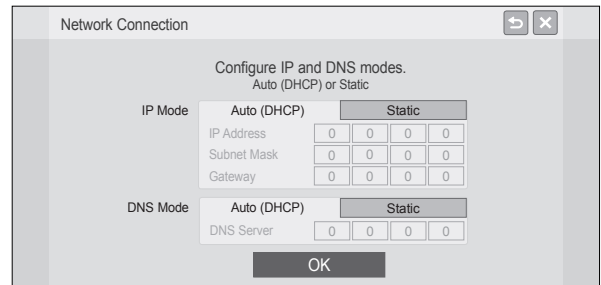

(Continued on next page)

IP Environment Setup (Cont.)

(Continued from previous page)

Note: Make sure you have the network security password/PIN available if you are attempting to connect to a secured network.

Note: (AP List and Enter the SSID options only) As with a wired connection, a second Network Connection window will enable you to specify the IP and DNS configuration for this network connection. Auto (DHCP) tabs will be selected by default. If a DHCP server is configured and a static configuration is not required, you can simply select **OK** (on the screen) and then press **OK** on the Installer Remote. The DHCP server will assign an IP address and DNS server to the STB for this network connection once the STB successfully connects to the network. Otherwise, use the arrow keys to select the Static tab(s), and specify the static configuration data for both the IP and DNS modes. When all fields are completed, select **OK** (on the screen) and press **OK** on the Installer Remote.

2. Follow the on-screen instructions to complete the appropriate network configuration. Use the Installer Remote navigate fields and make entries, etc.

Once you have specified configuration details as necessary, the STB will attempt to connect to the network and you will see a progress screen that indicates status as each network element is confirmed (see example at right). If the network is connected successfully, a “Wireless network is connected” message will be displayed at the top of the screen and the network configuration data will be displayed in the lower half of the screen.

3. Select **Complete** (if not already selected), and then press **OK** on the Installer Remote to exit the Network Connection wizard and return to the IP Environment Menu.

Note: If the network connection is not successful, the progress screen will identify the network element in which the connection failed. Check your cabling and/or, if necessary, press **↶** on the Installer Remote to return to previous screens to verify the configuration data.



Network Status

This option enables you to check the status of the network connection.

Note: If both wired and wireless network connections were configured in a previous session in the IP Environment Menu, and a LAN cable is connected/detected between the STB and the network, the Network Status operation first will attempt to connect to the network via the wired connection. If a wired connection is not detected, the Network Status then will attempt a wireless connection, if one has been configured. On the other hand, if, during the current session, you configured first a wired and then a wireless network connection, the Network Status operation will first attempt to connect to the network via the wireless connection (i.e., the last connection configured).

1. With the IP Environment Menu on display, use the arrow keys on the Installer Remote to select **Network Status**. Then, press **OK**.

(Continued on next page)

(Continued from previous page)

A status screen will be displayed as the STB confirms each of the network elements, including the STB/TV status, the gateway status, the DNS status, and the Internet status (see example at right). If the network is connected successfully, a “Wired/Wireless network is connected” message will be displayed at the top of the screen and the network configuration data will be displayed in the lower half of the screen.

Note: If a problem is detected, the status screen will identify the network element in which the connection failed. Check cabling and/or configuration data, as necessary. If the status screen is still on display, you can select **Try again** and press **OK** to recheck the network status.

2. When the status screen shows that the network is connected, select **Complete** (if not already selected) and press **OK** on the Installer Remote to return to the IP Environment Menu.

Note: If you cancel the status check while it is in progress, the STB will exit both the status window and the IP Environment Menu. If you wish to return to the IP Environment Menu while the status check is in progress, press **↵** on the Installer Remote.

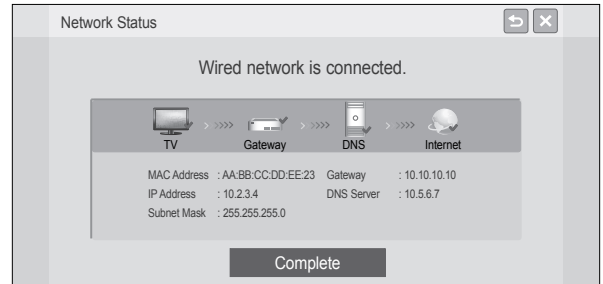

IP Stream Control

If necessary, due to an audio and/or video stream delay, IP Stream Control options enable you to compensate for synchronization irregularities by allowing audio PTS, video PTS, and PCR offset modifications. This menu also enables you to specify the IGMP version (2 or 3). Note that any modifications to these settings should be performed by qualified personnel only.

1. With the IP Environment Menu on display, use the arrow keys on the Installer Remote to select **IP Stream Control**. Then, press **OK**.
2. In the IP Stream Control pop-up window, use the Up/Down arrow keys on the Installer Remote to navigate to the appropriate field: Audio PTS Offset, Video PTS Offset, PCR Offset, or IGMP Version.
3. Use the Left/Right arrow keys to set the appropriate value for the selected field.

Note: Offset values represent offset time in milliseconds (ms) and can be adjusted from -500 ms to +500 ms in 10 ms increments.

4. When you have completed all modifications as required, either select **Close** and then press **OK** on the Installer Remote or press **↵** to return to the IP Environment Menu.

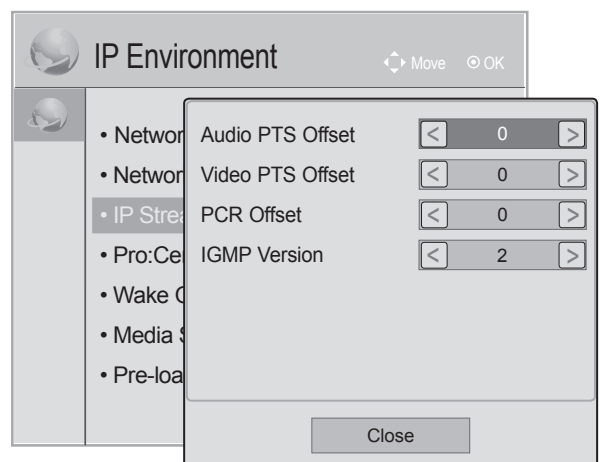

IP Environment Setup (Cont.)

Pro:Centric Setup

Pro:Centric options enable you to configure the STB with the appropriate settings to connect to the Pro:Centric server. Use the Up/Down arrow keys on the Installer Remote to navigate between fields.

1. With the IP Environment Menu on display, use the arrow keys on the Installer Remote to select **Pro:Centric**. Then, press **OK**.

Note: Options that are initially grayed out/inaccessible in the Pro:Centric Menu are dependent upon other settings in the display. For example, if "IP" is selected in the Media Type field, the Server IP and Port Number fields become accessible.

2. Refer to the appropriate subsection(s) below to configure the STB's Pro:Centric settings to match those of the Pro:Centric server.

While the Pro:Centric application (Mode) itself is an additional feature, the appropriate Pro:Centric server configuration must be completed to enable TV E-Z Installation (configuration and software/firmware) data downloads and, if configured, the Pro:Centric application download.

Note: For those fields that permit direct entry of numerical values (for example, Server IP, Port Number, Data Channel, etc.), once you key in the maximum number of digits allowed in the highlighted field, the next available field will be highlighted.

RF Configuration

- a) In the Media Type field, use the Left/Right arrow keys to select **RF**.

Note: If the Media Type has already been set in the EZ-Manager Wizard, the specified value will be reflected in this field.

- b) In the Data Channel field, either key in or use the Left/Right arrow keys to select the RF channel number that will be used by the Pro:Centric server as its data channel. The Data Channel value can be set from 0 (disabled) to 135.*

For STBs in Pass-through Mode or FTG Mode, if this item is left at its default value (255), the STB's Data Channel Auto Search feature will be enabled. See Installer Menu item 119 DATA CHANNEL description on page 33 for further information.

Note: If the Data Channel has already been set in the Installer Menu (Installer Menu item 119) or in the EZ-Manager Wizard, the specified channel will appear in this field. If you change the Data Channel in this menu, Installer Menu item 119 will now show the value you entered here.

IP Configuration

- a) In the Media Type field, use the Left/Right arrow keys to select **IP**.

Note: If the Media Type has already been set in the EZ-Manager Wizard, the specified value will be reflected in this field.

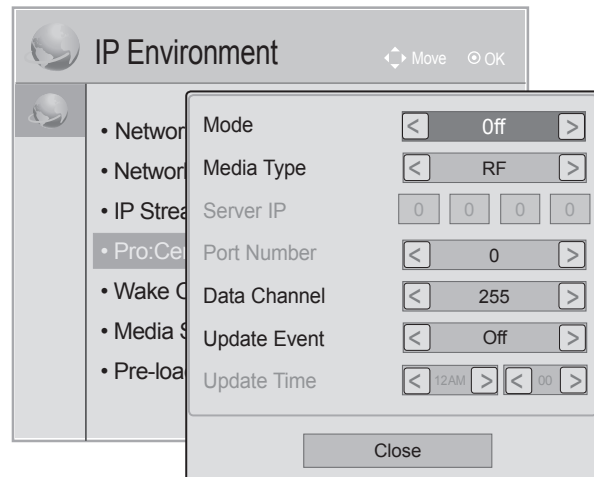

(Continued on next page)

* PCS150R and later Pro:Centric servers do not support HRC or IRC cable channel frequencies.

(Continued from previous page)

Note: Setting the Media Type to “IP” automatically sets the Data Channel field to “253.” You cannot alter this setting (unless you revert Media Type to “RF”). Also, it is not possible to directly enter “253” in the Data Channel field.

- b) In the Server IP and Port Number fields, either key in or use the Left/Right arrow keys to select the appropriate values for the Pro:Centric server IP address and port number. The IP address must match the IPv4 multicast address and the port number must match the port number that is set in the Pro:Centric server.

Note: If the server IP address and port number have already been set in the EZ-Manager Wizard, the specified data will be reflected in these fields.

Pro:Centric Application Mode Configuration

In the Mode field, use the Left/Right arrow keys to select the appropriate Pro:Centric Application Mode setting—**Off**, **FLASH**, **GEM**, or **HTML**. If the Pro:Centric Mode is set to “Off,” Pro:Centric application data will not be downloaded.

Note: If the mode has already been set in the Installer Menu (item 098 PRO:CENTRIC) or in the EZ-Manager Wizard, the specified mode will be reflected in this field. If you change the mode in this menu, Installer Menu item 098 will now reflect the value you selected here.

3. In the Update Event field, use the Left/Right arrow keys to select **On** or **Off**, as required. Based on the Update Time settings, the Wake for Update feature wakes the STB once daily to check for, and if applicable, download updates from the Pro:Centric server. See Installer Menu item 121 UPDATE TIME HR description on page 34 for additional information on Wake For Update functionality. If you set Update Event to “On,” specify the appropriate Wake For Update time in the Update Time fields, as desired. Note that the Update Time set in this menu is based on a 12-hour clock. Ensure the AM/PM specification is set accordingly.
4. Once all fields are completed as required, either select **Close** and then press **OK** on the Installer Remote or press **↵** to return to the IP Environment Menu.

Wake On LAN Setup

The Wake On LAN feature enables the STB to receive software updates and/or be powered ON upon receipt of Wake Up Frame packets and/or Magic Packet data via the wired LAN or upon receipt of Magic Packet data from the Wi-Fi network. To facilitate use of this feature, note that the appropriate wired connection must be made and/or the wireless network connection must be configured. This menu option enables you to specify Wake On LAN parameters.

1. With the IP Environment Menu on display, use the arrow keys on the Installer Remote to select **Wake On LAN**. Then, press **OK**.
2. In the Wake On LAN pop-up window, use the Up/Down arrow keys on the Installer Remote to navigate between fields, and use the Left/Right arrow keys to select the appropriate value—Disabled, Update, or Power ON—for each parameter.
3. Once all fields are completed as required, either select **Close** and then press **OK** on the Installer Remote, or press **↵** to return to the IP Environment Menu.

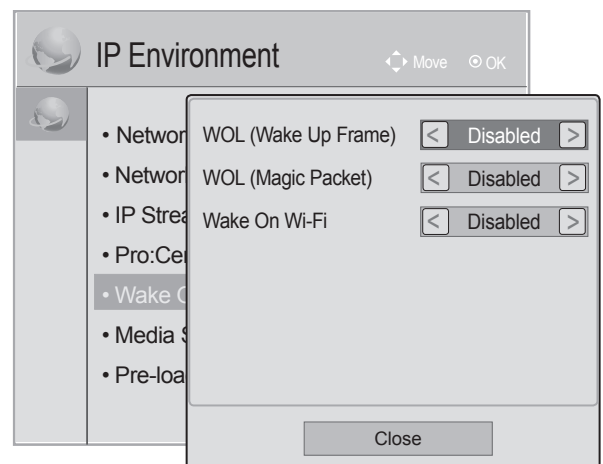

IP Environment Setup (Cont.)

Media Share Setup

Media Share allows you to enable Smart Share™, Wi-Fi Screen Share, and DMR options on the STB.

- The LG Smart Share feature allows guests to see data on the STB/display shared by DLNA Certified® devices on the same network.
- Wi-Fi Screen Share enables data sharing with the STB from a Wi-Fi Direct®, Smart Share enabled device or screen sharing with a Smart Mirroring or Wireless Display (WiDi) capable device (e.g., a laptop with Intel® hardware).
- DMR enables the STB to act as a Digital Media Renderer (DMR) device to receive content from DLNA Certified devices on the same network.

Note: Wi-Fi Screen Share and DMR can only be enabled if Smart Share is enabled. See also Reference section, “Wi-Fi Screen Share Features,” for additional information on these features.

1. With the IP Environment Menu on display, use the arrow keys on the Installer Remote to select **Media Share**. Then, press **OK**.
2. In the Media Share pop-up window, use the Up/Down arrow keys on the Installer Remote to navigate between fields, and use the Left/Right arrow keys to select the appropriate value—Disabled or Enabled—for each of the Smart Share, Wi-Fi Screen Share, and DMR parameters.

Note: If you wish to select pre-loaded Wi-Fi Screen Share applications to include on the STB/display Application Launch bar (see “Pre-loaded Applications” on following page), both the Smart Share and Wi-Fi Screen Share options must be enabled.

3. Once Smart Share is enabled, the Edit option for the TV Name field becomes accessible, and you can specify a name for this STB so that it is easy to identify and differentiate from other STBs/TVs for which sharing has been enabled.

To edit the STB name, use the Up/Down arrow keys to select **Edit**, and then press **OK**. Then, use the arrow and/or number keys on the Installer Remote to specify a name.

Note: The default name of each STB-2000 is its serial number. While Smart Share, Wi-Fi Screen Share, and DMR settings are clonable, the STB name cannot be cloned.

4. Once all fields are completed as required, either select **Close** and then press **OK** on the Installer Remote or press **↵** to return to the IP Environment Menu.

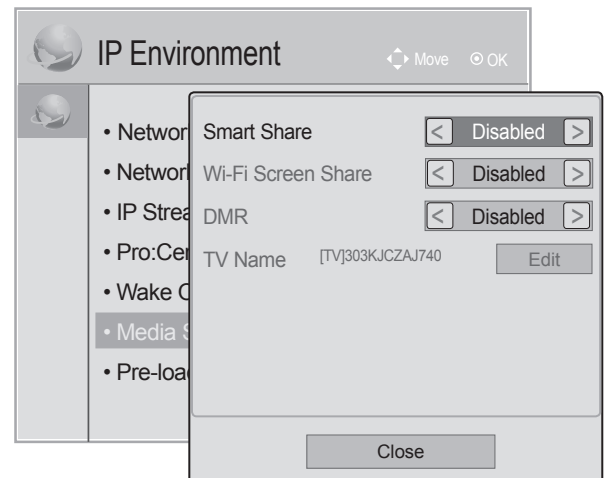

Pre-loaded Applications

This option allows you to select which of the pre-loaded application icons to display on this STB/display panel's Application Launch bar. The Application Launch bar is available when the Pro:Centric application is disabled. If the Pro:Centric application is enabled, it is not necessary for pre-loaded applications to be selected as described below.

When the Pro:Centric application is disabled, the selected applications are available to end users via the PORTAL button on the remote control and appear in the Application Launch bar along the bottom of the display screen.

1. With the IP Environment Menu on display, use the arrow keys on the Installer Remote to select **Pre-loaded Apps**. Then, press **OK**.
2. Available application options will be displayed in a horizontal scrollable list along the bottom of the screen. Use the Left/Right arrow keys to highlight the application you wish to select or de-select, and press **OK** on the Installer Remote. When an application is selected, a red checkmark is displayed at the top left of its icon.

The available application list includes three Wi-Fi Screen Share applications: Wi-Fi Direct, Smart Mirroring, and WiDi. In order to select any of these applications, you must first enable the appropriate Media Share options. See "Media Share Setup" on the previous page.

3. When you are done selecting the pre-loaded application icons to be displayed in the Application Launch bar, as required, press **↵** to return to the IP Environment Menu.

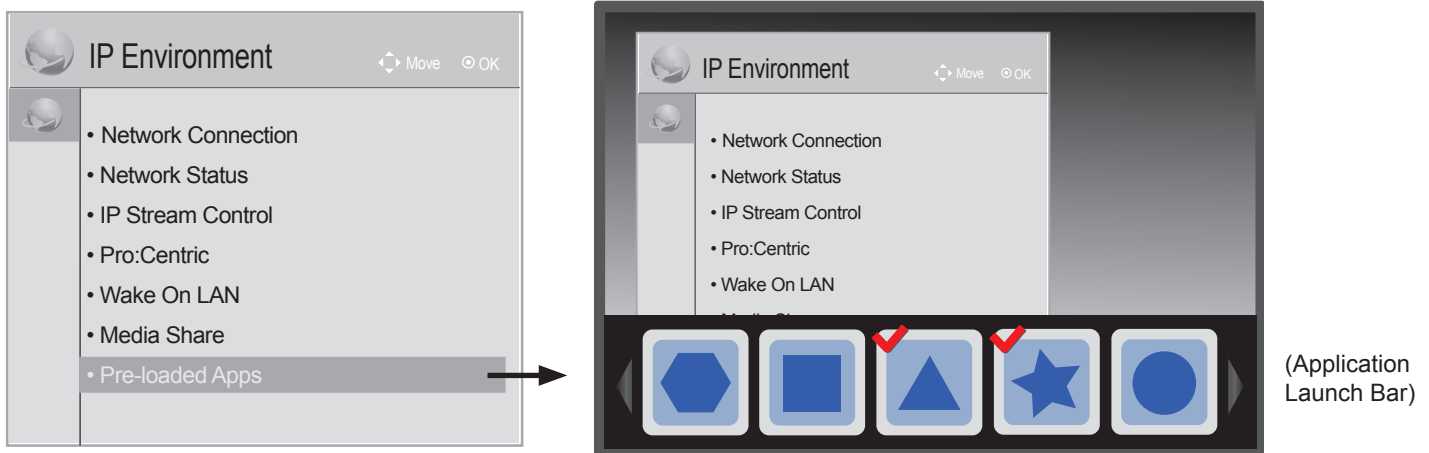

Reference: Upgrading STB Software using a USB Memory Device

This section describes how to update STB (CPU) and/or PTC software using the USB Download Menu, though you may also use the LG Smart Install utility to upgrade software, if desired. See “LG Smart Install Utility” on pages 23 to 24 for further information.

Before You Begin

- Software upgrade files must be stored in a folder named “LG_DTV” in the root directory of the USB memory device.
- Ensure the USB device has been formatted with FAT format.

Upgrade the STB/PTC Software

Note: You can check the STB/PTC software versions by accessing the STB Installer Menu with the Installer Remote. See “Accessing the Installer Menu” on page 25 for further information. PTC and CPU versions are displayed in the Installer Menu footer.

Note for STB CPU Software Upgrade only: If the STB detects a later version of software on the USB device, it will automatically display a dialog from which you can start the software upgrade immediately. Otherwise, you can close the dialog, and access the USB Download Menu as described below.

1. Turn ON the STB/display panel, and then insert the USB memory device into either of the USB ports on the STB.
2. Press **MENU** on the Installer Remote to display the STB setup menus (STB is in Pass-through Mode) or the Function Menu (STB is not in Pass-through Mode).
3. Use the arrow navigation keys to select/highlight either the **Option** menu icon from the STB setup menus or the **Lock** menu icon from the Function Menu. Then, press the number “7” key a total of seven times to display the USB Download Menu.
4. Use the Up/Down arrow keys to select **Upgrade STB Software** or **Upgrade PTC Software**, as applicable, and press **OK**.
5. In the next window (STB Software Update or Upgrade PTC Software depending on your selection in step 4), select/highlight the update file to install, and then press **OK**.

Note: Do not select Forced Update options unless you have been specifically instructed to do so or have previous experience with Expert Software Updates.

Update completion progress will be displayed on the screen in a new window. Do NOT remove the USB device until the software upgrade is complete. When the software upgrade is complete, the STB will reset with an automatic restart.

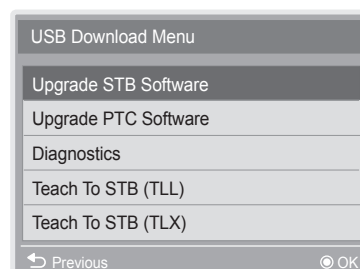

Note: The Diagnostics option in this menu is for service use only.

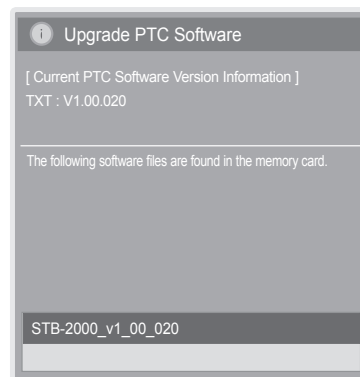
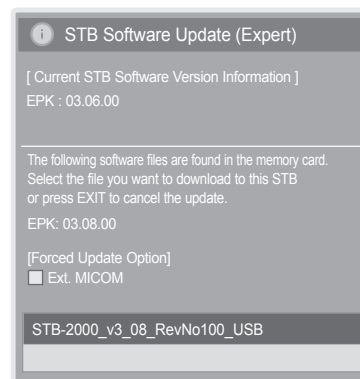

Reference: Display Panel Specifications

This section describes the types of commercial display panels that may be used with the STB-2000.

LG Hospitality TV Panels

The STB-2000 may be used with LG Hospitality TVs (LP645H, LT670H, etc.) that support Multiple Protocol Interface (MPI).

Use the MPI/MTI cable provided to connect the RJ-12 DISPLAY CONTROL 2 port on the STB-2000 front jack panel to the MPI port on the rear jack panel of the display.

LG Commercial Monitors & Public Display TV Panels

The STB-2000 may be used with LG Commercial Monitors (M3203CCBA, M3204C, etc.) or Public Display TVs (LD450C, LT560C, etc.) that support the TV-Link Monitor (TLM) interface.

Use the 3.5 mm-to-DB9 TLM cable provided to connect the 3.5 mm DISPLAY CONTROL 1 jack on the STB-2000 rear jack panel to the RS-232 CONTROL connector on the rear jack panel of the display.

Note that when you use this type of display panel, you must set Installer Menu item 113 PANEL TYPE appropriately. The PANEL TYPE setting is determined by the input commands supported by the display panel. If you are using an LG Commercial Monitor or Public Display TV that does not support xb input commands, set Installer Menu item 113 to 2. If you are using an LG Commercial Monitor or Public Display TV that does support xb input commands, set Installer Menu item 113 to 4 (default).

Note: Installer Menu item 113 values 0, 1, and 3 are available to support legacy panel types.

Commercial Non-LG TV Panels

The STB-2000 may be used with commercial non-LG TVs that support SONIFI's Multiple Television Interface (MTI) protocol.

Use the MPI/MTI cable provided to connect the RJ-12 DISPLAY CONTROL 2 port on the STB-2000 front jack panel to the MTI (typically labeled "DATA") port on the rear jack panel of the display.

Note that some MTI interface configuration may be required on non-LG TVs. Refer to the TV manufacturer's documentation to determine if any configuration is required.

Reference: STB Aux Input Configuration

DIRECT ACCESS Tuning *		STB		ENABLE					MPI DATA				Installer Menu Item 046 START AUX SRCE (Start Aux Source) Value
				Installer Menu			MPI DATA STATUS TYPE 0x41 SOURCES ENABLED (R/W)		DATA STATUS TYPE 0xD2 CURRENT AV SOURCE (R)		DATA STATUS TYPE 0x0D AUX SOURCE (R)		
Installer Menu Item 029 OLD OCV = 0	Installer Menu Item 029 OLD OCV = 1	Aux Input	Input Mode	Item	Function	Value	Enable Bit	Label	Value	Value	Description		
131	91	Video1 (Rear)	CV	39	REAR AUX EN	1	1	Rear Video (Aux)	1	0	VIDEO	1	
132	92	HDMI2	DTV	91	HDMI2 ENABLE	1	2	S-Video Rear	2	0	VIDEO	5	
			PC			2				2	COMPUTER		
133	93	HDMI1	DTV	35	HDMI1 ENABLE	1	3	Front Computer	3	0	VIDEO	3	
			PC			2				2	COMPUTER		

* Use Installer Remote to enter channel number indicated based on OLD OCV Installer Menu setting.

Reference: Auto Input(s) Sensing Feature

This section provides detailed settings information for Installer Menu item 042 AUTO INPUTS.

Note: When both item 042 AUTO INPUTS *and* item 041 SIMPLINK EN are enabled in the Installer Menu, HDMI inputs will be detected by SIMPLINK, but the Auto Input(s) Sensing Feature will not function.

In the Installer Menu, an informational code is displayed at the right of each Auto Inputs value, for example:

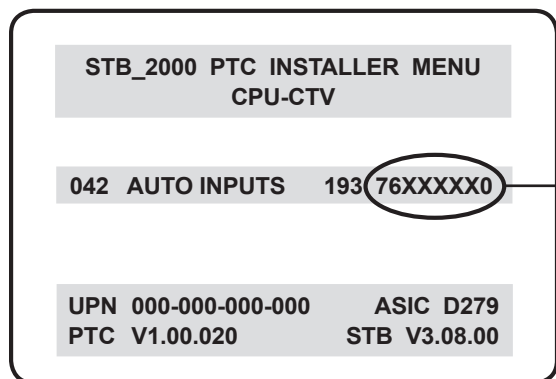

AUTO INPUTS Display Code

This example illustrates Installer Menu item 042 value 193, which enables auto-sensing for all available Aux inputs. The input #s in the display code (7, 6, 0 in this example) identify the enabled Aux inputs. See first table below for a listing of the STB-2000 Aux inputs and their corresponding display code input #s. The second table below shows the display codes for all item 042 values.

Each code consists of eight characters that identify the Aux input(s) for which auto-sensing is enabled. The following table identifies the Installer Menu display code Input # for each Aux input that is available on the STB-2000. The table also identifies the Installer Menu item associated with each Aux input. Remember that in order for auto-sensing to be enabled for an input, that input must also be enabled in the Installer Menu.

Installer Menu Display Code Input #	Aux Input	Installer Menu	
		Item	Function
0	AV1	039	REAR AUX EN
6	HDMI 1	035	HDMI1 ENABLE
7	HDMI 2	091	HDMI2 ENABLE

To disable auto-sensing for all available Aux inputs, set item 042 to 0. To enable auto-sensing for all available Aux inputs, set item 042 to 255. All other available settings (i.e., settings for individual inputs), are listed in the table below.

Item 042 Value	Inputs			Installer Menu Display
	AV1	HDMI 1	HDMI 2	
001	Enabled	Disabled	Disabled	DDXXXXX0
064	Disabled	Enabled	Disabled	D6XXXXXD
065	Enabled	Enabled	Disabled	D6XXXXX0
128	Disabled	Disabled	Enabled	7DXXXXXD
129	Enabled	Disabled	Enabled	7DXXXXX0
192	Disabled	Enabled	Enabled	76XXXXXD
193	Enabled	Enabled	Enabled	76XXXXX0

X = Aux input source is Disabled or Not Available (i.e., on this STB model)

D = Auto-sensing for input is Disabled

Input # = Auto-sensing for input is Enabled

Reference: Restoring Factory Defaults on the STB(s)

This section describes how to restore all factory defaults or just the Installer Menu factory defaults either on a single STB that is currently in Pass-through or FTG Mode or on multiple STBs that are currently in FTG Mode.

Restore All Factory Defaults

This section describes how to restore a single STB, regardless of its current mode, to a factory default condition. The following procedure requires that you contact LG technical support to obtain a predefined value/password for Installer Menu item 117 FACT DEFAULT that enables access to initiate a factory “IN-STOP” process, which restores all factory defaults on the STB. This procedure will also reactivate the EZ-Manager Wizard.

1. Use the Installer Remote to access the STB’s Installer Menu.
2. Navigate to Installer Menu item 117 FACT DEFAULT, and key in the value provided by technical support. Then, press **OK**.
3. At the prompt for confirmation, key in the password provided by technical support. This will initiate the IN-STOP that restores the factory defaults on the STB.

Installer Menu Item 117 FACT DEFAULT

If the STB is currently in Pass-through Mode, you can set Installer Menu item 117 FACT DEFAULT to 1 to restore the Installer Menu factory defaults and clear the PTC Channel Map, including any assigned channel icons and custom text labels. Note, however, that if a complete restoration of the STB’s factory defaults is required, see “Restore All Factory Defaults” above.

Additional FTG Mode Options

There are two additional options for restoring Pass-through Mode/Installer Menu factory defaults on STBs that are in FTG Mode. The first enables you to restore a single STB to Pass-through Mode, while the second enables you to restore multiple STBs to Pass-through Mode at one time. However, both options require that you create a “Zero Mapped Channels” FTG Configuration (.tlx) file, i.e., an FTG Configuration file with no data. Refer to the *Free-To-Guest (FTG) File Manager User Guide* for further information.

- Using a USB memory device, “Teach” a “Zero Mapped Channels” FTG Configuration (.tlx) file to the STB. Refer to “Teaching FTG Configuration to an STB” on pages 47 to 48 for further information on the Teaching process.
- If your system uses a Pro:Centric server for remote management/administration, use the Pro:Centric server Admin Client to load a “Zero Mapped Channels” FTG Configuration (.tlx) file on the Pro:Centric server. Refer to the *Pro:Centric Server Admin Client User Guide* for further information.

Reference: Using the STB's Zoning Features

This section describes the TV Zoning and Wi-Fi Zoning features available with the STB-2000. These features are primarily intended for use when the STB is configured for FTG Mode via CPU operation; however, Wi-Fi Zoning, along with selected elements of TV Zoning (Installer Menu and TV [STB] Setup Menu profile Zone assignments), may also be used with STB cloning processes using a USB memory device / TLX file. Refer to the appropriate section(s) below for further information on the Zoning features and how to set the TV Zone # or Wi-Fi Zone # in an STB that is currently in Pass-through Mode.

TV Zoning Feature

The TV Zoning feature enables you to create localized configurations for STBs/displays in selected locations, or "Zones," within the installation environment, for example, a hotel lobby, fitness center, restaurant, etc.

Using the TV Zoning Feature with FTG Mode Configuration

The FTG File Manager may be used to create an FTG Configuration (.tlx) file that contains multiple Installer Menu and TV Setup Menu profiles, each with its own Zone assignment. Up to nine unique Zones can be designated for STB-2000 FTG Installer Menu and/or TV Setup Menu profiles. Zone restrictions can also be placed on individual channels in the FTG Channel Map. Thus, for example, you may create an FTG Installer Menu and/or TV Setup Menu profile to specifically configure an STB/display in the hotel lobby and also restrict the channels that are available to be tuned on that STB/display.

The TV Zone # must be set appropriately on each STB in order for the STBs to be configured correctly. See "Set the TV Zone # and/or Wi-Fi Zone # in the STB" on page 71, and set the TV Zone # in all the STBs in a select area, so that the STBs/displays are configured with corresponding FTG Installer Menu and/or TV Setup Menu settings and/or can omit channels that have been restricted in the FTG Channel Map. TV Zone 0 is the default TV Zone #.

The following subsections briefly describe how to assign Zone designations in the FTG File Manager. Refer to the ***Free-To-Guest (FTG) File Manager User Guide*** for further information.

FTG Installer Menu Profile Zone Assignments

The FTG File Manager main screen enables you to change the Zone assignment (default = Zone 0) for each Installer Menu profile to be included in an FTG Configuration (.tlx) file. For example, you may wish to create one STB-2000 Installer Menu profile for the hotel lobby and another STB-2000 Installer Menu profile for the fitness center, both of which are different from the Installer Menu profile used for standard guest rooms. The TV Zoning feature enables you to save multiple STB-2000 FTG Installer Menu profiles, each with its own Zone assignment, in one FTG Configuration file. If each STB in the aforementioned locations (Zones) has had its TV Zone # set appropriately, as described in the procedure on page 71 or via the EZ-Manager Wizard, the STB(s) will only be configured by the Installer Menu profile that matches its(their) Zone setting.

In the FTG File Manager main screen, you can also edit the Zone assignment for each Installer Menu profile and/or TV Setup Menu profile already present in the FTG Configuration List and TV Setup Menu List windows.

Note: See also the FTG File Manager main screen overview on page 52. In addition, note that TV Setup Menu profiles cannot be created in the FTG File Manager; they must be "Learned" from a TV/STB.

FTG Channel Map Zone Restrictions

The FTG Channel Map Editor in the FTG File Manager's FTG Channel Map Configuration Utility enables you to place Zone restrictions on individual channels that may be prohibited or deemed unsuitable for certain locations. In the FTG Channel Map Editor, one or more Zone restrictions (1–8) may be placed on each channel that is to be restricted. For example, if you wish to restrict a channel from Zones 2 and 4, select both "Zone 2" and "Zone 4" in the Zone Restriction section of the FTG Channel Map Editor screen when defining or editing that channel.

Reference: Using the STB's Zoning Features (Cont.)

Note: While a channel can be restricted from up to eight Zones, an STB can only ever be in (set for) one Zone. See also the FTG Channel Map Editor overview on page 54.

At the same time, keep in mind that the TV Zone designations are not mutually exclusive. That is, you may opt to place Zone restrictions on selected channels in the FTG Channel Map, but at the same time, you can choose to configure all STBs/displays at the site with the same Installer Menu and/or TV Setup Menu settings. For example, an FTG Configuration (.tlx) file being used to configure the STBs/displays at a site may contain multiple Installer Menu and TV Setup Menu profiles with different Zone assignments, as well as an FTG Channel Map with Zone restrictions on several channels. Each STB that still has the default TV Zone 0 setting will *only* be configured by the Installer Menu and/or TV Setup Menu profile(s) with a Zone 0 designation. If, on the other hand, the TV Zone # is set to 1, the STB will first look in the file for the STB-2000 Installer Menu and/or TV Setup Menu profile(s) with a Zone 1 designation. If none of the STB-2000 Installer Menu and/or TV Setup Menu profiles has a Zone 1 designation, the STB will then look for the STB-2000 profile(s) with a Zone 0 designation. For the FTG Channel Map configuration, when the TV Zone # is set to 0, the STB will ignore any Zone restrictions (1–8) that may be placed on channels in the FTG Channel Map. However, when the TV Zone # is set to 1, the STB will omit any channels that have been restricted from Zone 1 in the FTG Channel Map.

Using the TV Zoning Feature with Cloning Configuration

A location-specific configuration / TLX file may be saved (Learned) from an individual STB as part of a Master STB Setup and then be used during Teaching. For example, if the TV Zone # in the Master STB is set to 3 before Learning is initiated, the Master STB's Installer Menu and TV Setup Menu profiles will be saved with the TV Zone 3 assignment when Learning is completed. In order to configure the Target STBs with the Zone 3 Installer Menu and TV Setup Menu profiles Learned from the Master STB, you must set the TV Zone # accordingly in the Target STBs before transferring (Teaching) the Master STB Setup. See “Set the TV Zone # and/or Wi-Fi Zone # in the STB” on the following page. Also, see “Learning / Teaching a Master STB Setup using a TLX File” on pages 40 to 42 for additional information on the cloning processes. TV Zone 0 is the default TV Zone #.

Wi-Fi Zoning Feature

The Wi-Fi Zoning feature enables you to use a TLX file to configure an individual STB or group of STBs with a particular Wi-Fi access point's login data to create “Wi-Fi Zones” within the installation environment.

Using the Wi-Fi Zoning Feature with FTG Mode Configuration

The FTG File Manager may be used to create an FTG Configuration (.tlx) file with an FTG Installer Menu profile that contains login data for multiple Wi-Fi access points, each assigned a Wi-Fi Zone #. Up to 99 Wi-Fi Zones can be designated within each FTG Installer Menu profile, thus allowing for distribution of the Wi-Fi network load. For example, if a site has 50 STB-2000s within close proximity, you may wish to create 10 Wi-Fi Zones, each with its own access point that has unique login data, so that no more than five of the STBs are connected to one access point at any given time.

In order for an STB to be configured by the proper Installer Menu profile with the desired Wi-Fi access point login data for wireless networking (i.e., SSID, security type, and security key), you must set both the TV Zone # and the Wi-Fi Zone # in the STB (see “Set the TV Zone # and/or Wi-Fi Zone # in the STB” on the following page for further information). If the Wi-Fi Zone # in the STB is set to 0 (default), the STB will not obtain access point login data from the Installer Menu profile with which it is configured.

Refer to the **Free-To-Guest (FTG) File Manager User Guide** for further information on defining Wi-Fi Zones in the FTG File Manager.

Reference: Using the STB's Zoning Features (Cont.)

Using the Wi-Fi Zoning Feature with Cloning Configuration

A location-specific Wi-Fi configuration / .tlx file may be saved (Learned) from an individual STB as part of a Master STB Setup and then be used during Teaching. First, the wireless network (i.e., the access point login data) must be configured in the Master STB's IP Environment Menu (see "Wireless Network Connection" on page 57). Then, a Wi-Fi Zone # must be set in the Master STB (see "Set the TV Zone # and/or Wi-Fi Zone # in the STB" below). If desired, a TV Zone # may also be set in the Master STB.

For example, if the Wi-Fi Zone # is set to 4 and the TV Zone # is set to 5 before Learning is initiated, after Learning is completed, the Master STB's Installer Menu profile will be saved with the Zone 5 assignment, and within that Installer Menu profile, the access point login data for wireless networking (i.e., SSID, security type, and security key) will be saved with a Wi-Fi Zone 4 assignment. In order to configure the Target STBs with the proper Installer Menu profile and access point login data, you must set both the TV Zone # and the Wi-Fi Zone # in the Target STBs accordingly before transferring (Teaching) the Master STB Setup. See "Set the TV Zone # and/or Wi-Fi Zone # in the STB" below. Also, see "Learning / Teaching a Master STB Setup using a TLX File" on pages 40 to 42 for additional information on the cloning processes. If the Wi-Fi Zone # in the STB is set to 0 (default), the STB will not obtain access point login data from the Installer Menu profile with which it is configured.

Set the TV Zone # and/or Wi-Fi Zone # in the STB

You can set the TV Zone # and/or the Wi-Fi Zone # in the EZ-Manager Wizard (see "EZ-Manager Wizard" on pages 15 to 22) or, if the STB is in Pass-through Mode, via the STB's setup menus as described below. Note that the following procedure can only be performed while the STB is in Pass-through Mode. You will also be able to specify a Label (North, South, East, West) and Room Number for this STB, if desired.

1. Turn ON the STB/display panel.
2. Press **MENU** on the Installer Remote, and use the arrow navigation keys to select/highlight the **OPTION** menu option. Then, press **OK**.
3. Use the Up/Down arrows to select **Zones & Room Number**, and then press **OK**.
4. In the Zones, Label, and Room Number pop-up window, complete the appropriate fields as described below. Use the Left/Right arrow keys on the Installer Remote to navigate between each of the fields.
 - **Wi-Fi Zone:** Enables you to set a Wi-Fi Zone # so that the STB can be configured with a particular access point's login data for wireless networking. Login data (i.e., SSID, security type, and security key) may be provided in a TLX file to be used for configuration. If the Wi-Fi Zone # is set to 0, the STB will not be configured with login data from a TLX file.

To assign a Wi-Fi Zone, navigate to the Wi-Fi Zone field at the far left of the screen, and use the Up/Down arrow keys to specify the desired Wi-Fi Zone # (1–99).
 - **TV Zone:** Enables you to set a TV Zone # so that the STB can be configured with Installer Menu and/or TV Setup Menu settings intended only for the assigned Zone. The Installer Menu and/or TV Setup Menu settings may be provided in a TLX file to be used for configuration. If the STB is being configured for FTG Mode via CPU, the TV Zone # setting also allows the STB to omit channels that have been restricted in the FTG Channel Map.

To change the TV Zone, navigate to the TV Zone field, and use the Up/Down arrow keys to specify the desired TV Zone # (0–8).

(Continued on next page)

Reference: Using the STB's Zoning Features (Cont.)

(Continued from previous page)

- **Label:** Allows you to select a North, South, East, or West text label for this STB. Use the Up/Down arrow keys to select the applicable label.
 - **Room Number:** Allows you to specify the number of the room in which the STB is located. You can use the number keys on the Installer Remote to direct enter a room number. Use the Dash key on the Installer Remote as necessary to toggle between number and letter characters in the Room Number field. Also, you can use the Flashback key on the Installer Remote to delete characters in this field.
5. When you have completed the fields as necessary, select **OK**, and then press **OK** on the Installer Remote to close the window and return to the Option Menu.
 6. Press **MENU** to return to TV viewing.

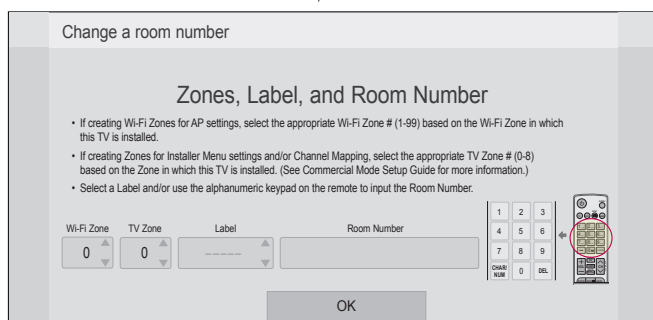
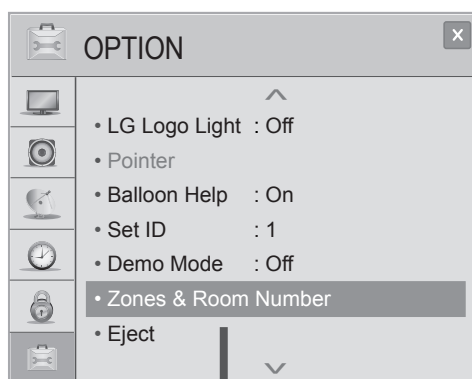

Reference: Wi-Fi Screen Share Features

When the STB's Wi-Fi Screen Share and DMR options are enabled in the IP Environment / Media Share Menu (see "Accessing the IP Environment Menu" and "Media Share Setup" on pages 56 and 62, as necessary), guests have the ability to use the following Wi-Fi Screen Share features:

- Wi-Fi Direct: Enables users to select a Wi-Fi Direct, Smart Share enabled device from which to view media files (photos, videos, music, etc.).
- Smart Mirroring / WiDi: Enables users to select a Smart Mirroring capable device or a WiDi capable device, whose screen can be displayed on the screen.

This section provides an overview of the Wi-Fi Direct and Smart Mirroring / WiDi functionality.

Accessing Wi-Fi Screen Share Features

The enabled status of the Wi-Fi Screen Share and DMR options indicated above is essential for guest access to Wi-Fi Screen Share features. Once these items are enabled, users can turn ON the Wi-Fi Direct and Smart Mirroring / WiDi features at any time from the STB menus—either the Option or the SmartShare Menu depending on whether the STB is or is not in Pass-through Mode.

When the Pro:Centric application is disabled on the STB, Wi-Fi Direct, Smart Mirroring, and WiDi features may also be accessible from the Application Launch bar that is activated via the PORTAL button on the remote. However, this requires that the pre-loaded application icons for each of these features has been selected in the IP Environment / Pre-loaded Apps Menu. See also "Pre-loaded Applications" on page 63.

The following subsections describe how to access the Wi-Fi Direct and Smart Mirroring / WiDi features.

STB Menus

Note: When Smart Share is enabled in the IP Environment Menu, regardless of whether Wi-Fi Screen Share is also enabled, the STB Name will be displayed (as "TV Name") in the Option and SmartShare STB menus described below (see also examples at right). However, the STB Name is not editable outside of the IP Environment Menu.

1. Turn ON the STB/display panel, and press **MENU** on the Installer Remote to display the STB setup menus (STB is in Pass-through Mode) or the Function Menu (STB is not in Pass-through Mode).
2. Use the arrow navigation keys to select/highlight either the **Option** menu icon from the STB setup menus or the **SmartShare** menu icon from the Function Menu. Then, press **OK**.
3. Use the Up/Down arrows to select either **Wi-Fi Direct** or **Smart Mirroring / WiDi**, and then press **OK**.

Note: These menu options are only available if the Wi-Fi Screen Share feature has been enabled in the Media Share Menu.

Depending on your selection in step 3, a Wi-Fi Direct or Smart Mirroring / WiDi pop-up window will be displayed.

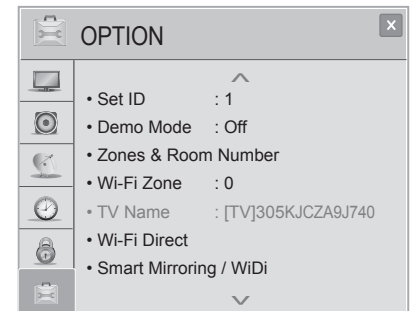

(STB in Pass-through Mode)

or

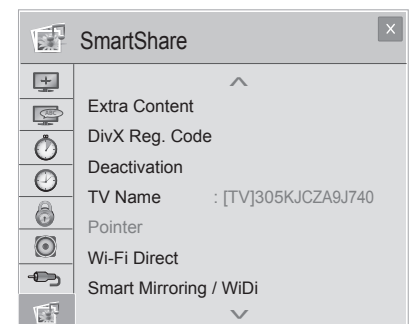

(STB not in Pass-through Mode)

Reference: Wi-Fi Screen Share Features (Cont.)

Application Launch Bar

Note: The Application Launch bar is only available when pre-loaded application icons are selected and when the Pro:Centric application is disabled on the STB. If the Pro:Centric application is loaded on the STB, you must access the Wi-Fi Screen Share options from the STB menus as described on the previous page.

1. Press **PORTAL** on the remote to display the Application Launch bar. All available application icons will be displayed along the bottom of the screen.
2. Use the Left/Right arrow keys on the remote to highlight the desired application to launch, and then press **OK** to select it.

Depending on your selection in step 2, a Wi-Fi Direct, Smart Mirroring, or WiDi pop-up window will be displayed.

Wi-Fi Direct

With the Wi-Fi Direct pop-up window on display, use the following procedure to turn ON Wi-Fi Direct and select a device to which to make a connection.

1. In the Wi-Fi Direct pop-up window, use the Left/Right arrow keys to select **On** in the Wi-Fi Direct field. This will prompt the STB to search for all available Wi-Fi Direct enabled wireless devices, including mobile devices, laptops, etc. Devices found will be listed in the lower half of the screen.

Note: If the search does not initially locate any devices, select **Rescan** and press **OK**.

2. Use the Up/Down arrow keys to select/highlight the device with which you wish to share, and then press **OK**.
3. A new pop-up window will prompt you to confirm your connection request. Select **Yes** and press **OK** to continue.

The share request will be sent to the targeted device. The user of that device may choose to allow or not allow the share connection. Similarly, once Wi-Fi Direct is turned ON, other devices may request share connections with this STB (pop-up share requests typically appear in the bottom right of the display screen).

4. If the share request is accepted, media files may now be shared between the device and the STB using Wi-Fi Direct. Select **Close** and press **OK** to exit the Wi-Fi Direct window.
5. To access media files/folders on the STB, either press **MENU** and select the **SmartShare** or **Input** menu icon, or press the **Input** key on the Installer Remote to select the Smart Share device. Then, select the desired media category to view files.



Wi-Fi Direct pop-up window display is the same whether the STB is or is not in Pass-through Mode.

Reference: Wi-Fi Screen Share Features (Cont.)

Smart Mirroring / WiDi

With the Smart Mirroring / WiDi pop-up window on display, use the following procedure to turn ON Smart Mirroring and WiDi and establish a connection.

Note: If you are accessing the Smart Mirroring or WiDi features from the Application Launch bar, each feature will have its own pop-up window. The example shown here illustrates the pop-up window that displays when the “Smart Mirroring / WiDi” option is selected from the STB menus.

1. In the Smart Mirroring / WiDi pop-up window, use the Left/Right arrow keys to select **On** in the Smart Mirroring / WiDi field.
2. Initiate the Smart Mirroring / WiDi connection from your Smart Mirroring / WiDi device. Note that you may be prompted to enter a PIN number displayed on the display screen into your Smart Mirroring / WiDi connection window to complete the connection.

Once the connection is established, the monitor display may be used as a second screen for the Smart Mirroring / WiDi device.



Smart Mirroring / WiDi pop-up window display is the same whether the STB is or is not in Pass-through Mode.

Reference: STB-2000 Jack Panels

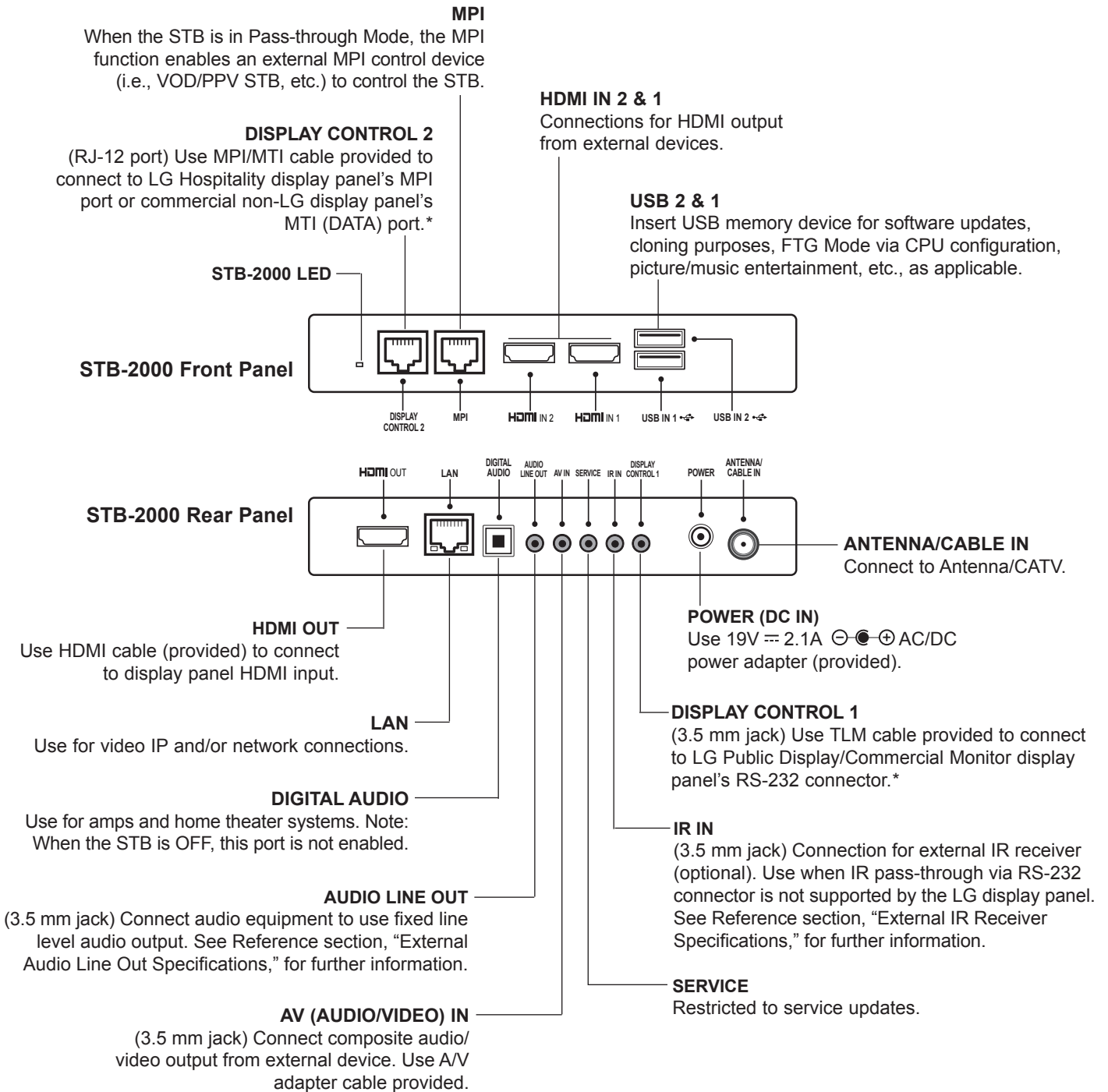

* Only one DISPLAY CONTROL connection should be used depending on the type of display panel to be controlled. Refer to "STB-2000 Cabling Connections" on pages 7 to 8, and/or see Reference section, "Display Panel Specifications," for information on determining the appropriate connection.

Reference: External IR Receiver Specifications

The IR IN 3.5 mm stereo jack on the rear panel of the STB-2000 provides an input for an optional external IR receiver (Example: Sung Nam Electronics EAD61273113). The jack provides external IR VCC of 3.5 volts. Refer to the following diagram for pinout details.

 **Caution: Do NOT plug in a mono connector, as this may damage the STB.**

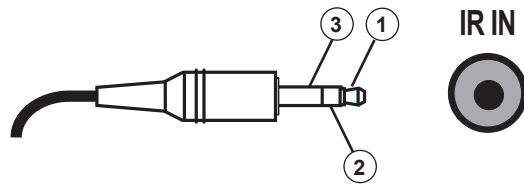

1	+3.5 v (VCC)
2	OUTPUT VOLTAGE (VOUT)
3	GND

Reference: External Audio Line Out Specifications

The AUDIO LINE OUT 3.5 mm stereo jack on the rear panel of the STB-2000 provides stereo fixed line level analog audio output for external audio equipment. Installer Menu item 097 AUDIO OUTPUT must be set to 9 to make analog audio output available. Refer to the following diagram for pinout details.

 **Caution: Do NOT plug in a mono connector, as this may damage the STB.**

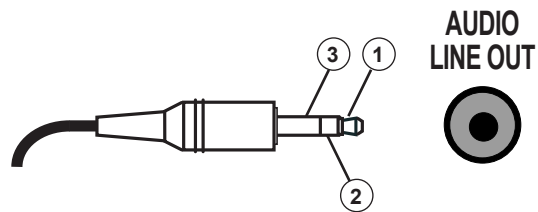

-
- | | |
|---|-----------------|
| 1 | LEFT (Tip) |
| 2 | RIGHT (Ring) |
| 3 | GROUND (Sleeve) |
-

Reference: Installer Remote Control Typical Key Functions

An LG Installer Remote is required to set up and operate the STB. The LG Installer Remote illustrated below shows typical remote control functions and is provided for reference only. See also “STB Installer Remote” information on the following page.

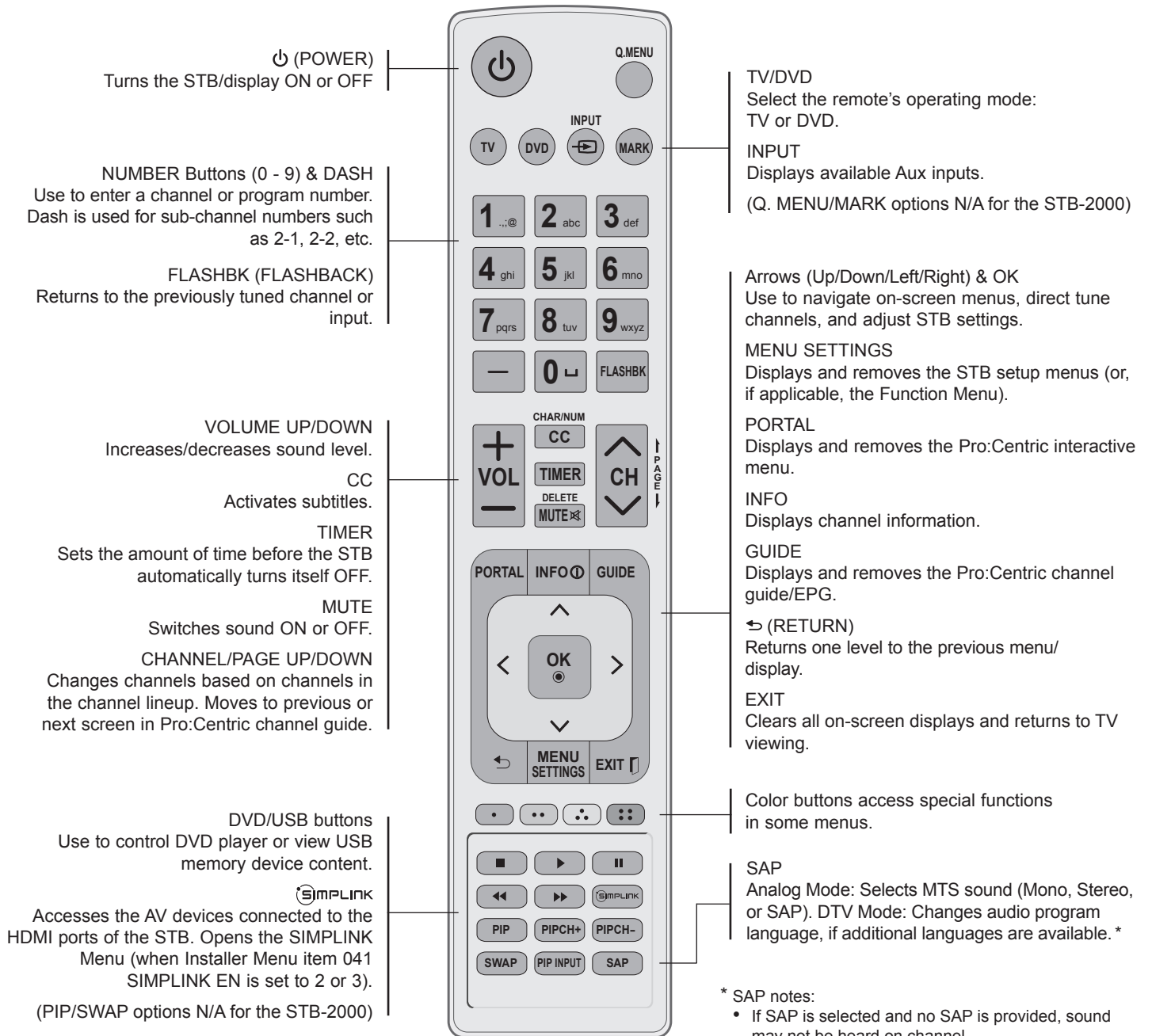

Reference: STB Installer Remote

If you are using an LG display panel, the LG remote provided with the display should be sufficient. However, if you are using a commercial non-LG display panel and/or if you intend to use multiple STBs/displays in a single room installation environment, an LG Installer Remote dedicated to STB control (see example at right) is available for purchase.

The STB Installer Remote illustrated on the right shows typical remote control functions and is provided for reference only.

For additional information and/or to purchase an STB Installer Remote, please contact your LG service representative.

Installer Remote Functionality

The STB Installer Remote provides the same standard configuration functionality as a typical LG Installer Remote, along with multi-code capability. See also “Installer Remote Control Typical Key Functions” information on the previous page.

Programming the STB Installer Remote (Multi-IR Code Feature)

This section describes how to program the STB Installer Remote to send unique IR codes based on “bed number” in a multi-STB/display single room installation. Up to nine beds can be programmed.

Note: The STB will always respond to the standard LG Installer Remote IR code scheme, regardless of its multi-code IR setting.

The following procedure describes how to program the bed number in the STB Installer Menu and in the STB Installer Remote.

1. Installer Menu item 020 FEATURE LEVEL determines the additional IR code scheme to which the STB will respond. Access the STB Installer Menu, and set item 020 to the desired value.

The STB Installer Remote must now be programmed to match the FEATURE LEVEL setting. That is, if item 020 is set to 17 for Bed 2, the STB Installer Remote must also be set to Bed 2.

Note: In its default state, the STB Installer Remote uses the standard LG Installer Remote IR code scheme.

2. On the STB Installer Remote, press and hold the **OK** button along with the desired (bed) number button.

The TV LED at the top left of the remote will light for three seconds and then turn OFF.

3. Once the TV LED turns OFF, release both buttons on the remote.
4. Verify the remote functionality, based on your settings.

Note: If necessary, you can restore the default STB Installer Remote IR code scheme by pressing and holding the **OK** button on the remote along with 0.

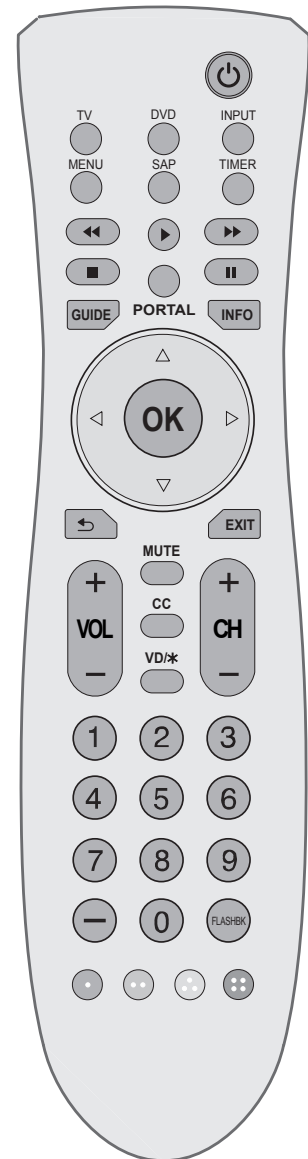

General Troubleshooting (Some Quick and Easy Tips for Resolving Problems)

Installation

Symptom	Possible Cause(s)	Possible Solution(s)
Cannot direct enter channel number.	(STB in Pass-through Mode) Installer Menu item 028 CH. OVERRIDE is set to 0, i.e., disabled (recommended setting).	If Installer Menu item 028 CH. OVERRIDE is set to 0, only channels that are active in the STB's channel lineup can be selected. Set CH. OVERRIDE to 1 to allow access for direct keypad entry to all channels.
	(STB in FTG Mode) The channel entered is not included in the FTG Channel Map.	Channel access is restricted to channels included in the FTG Channel Map. If necessary, make changes to the FTG Channel Map using the FTG File Manager.

Power

Symptom	Possible Cause(s)	Possible Solution(s)
No power.	See STB Quick Check flow chart on following page.	

Picture Reception and Sound

Symptom	Possible Cause(s)	Possible Solution(s)
No picture.	Display panel is turned OFF.	<ul style="list-style-type: none"> Turn display panel ON. Power failure?
	Antenna/cable not connected.	Connect antenna/cable signal to STB.
	Connections incorrect.	Check connections on STB, in particular, HDMI cabling.
	MPI not connected.	If applicable, connect MPI cable to MPI device.
	Encrypted program.	Try another channel.
	Wrong tuning band.	Adjust Installer Menu settings.
Normal picture, poor or no sound.	Audio muted.	Press MUTE or use Volume Up key to increase sound level.
	Broadcast problem.	Try a different channel.

Erratic Operation

Symptom	Possible Cause(s)	Possible Solution(s)
Installer Menu setup.	Wrong Installer Menu settings.	Adjust Installer Menu settings as required.

Installer Remote

Symptom	Possible Cause(s)	Possible Solution(s)
Remote doesn't work.	Display Control not connected properly.	Use appropriate Display Control cable (provided) to connect the STB to the display panel. See "STB Cabling Connections" information in this document.
	Remote not in TV Mode.	Use MODE key to select "TV"; puts remote into TV Mode.
	Not aimed at IR receiver.	Point remote at IR receiver on display panel.
	Remote too far from IR receiver or IR path is obstructed.	Move remote closer to IR receiver on display panel, darken room, and/or remove obstructions.
	MPI not connected.	If applicable, connect MPI cable to MPI device.
	Weak batteries.	Replace batteries.
	Wrong battery polarity.	Check that "+" and "-" match in battery compartment.
	Too much light in room.	Dim room light.
Wrong Installer Remote.	Requires compatible LG Installer Remote (see examples in this document). Contact your LG representative.	

Troubleshooting (Cont.)

STB Quick Check

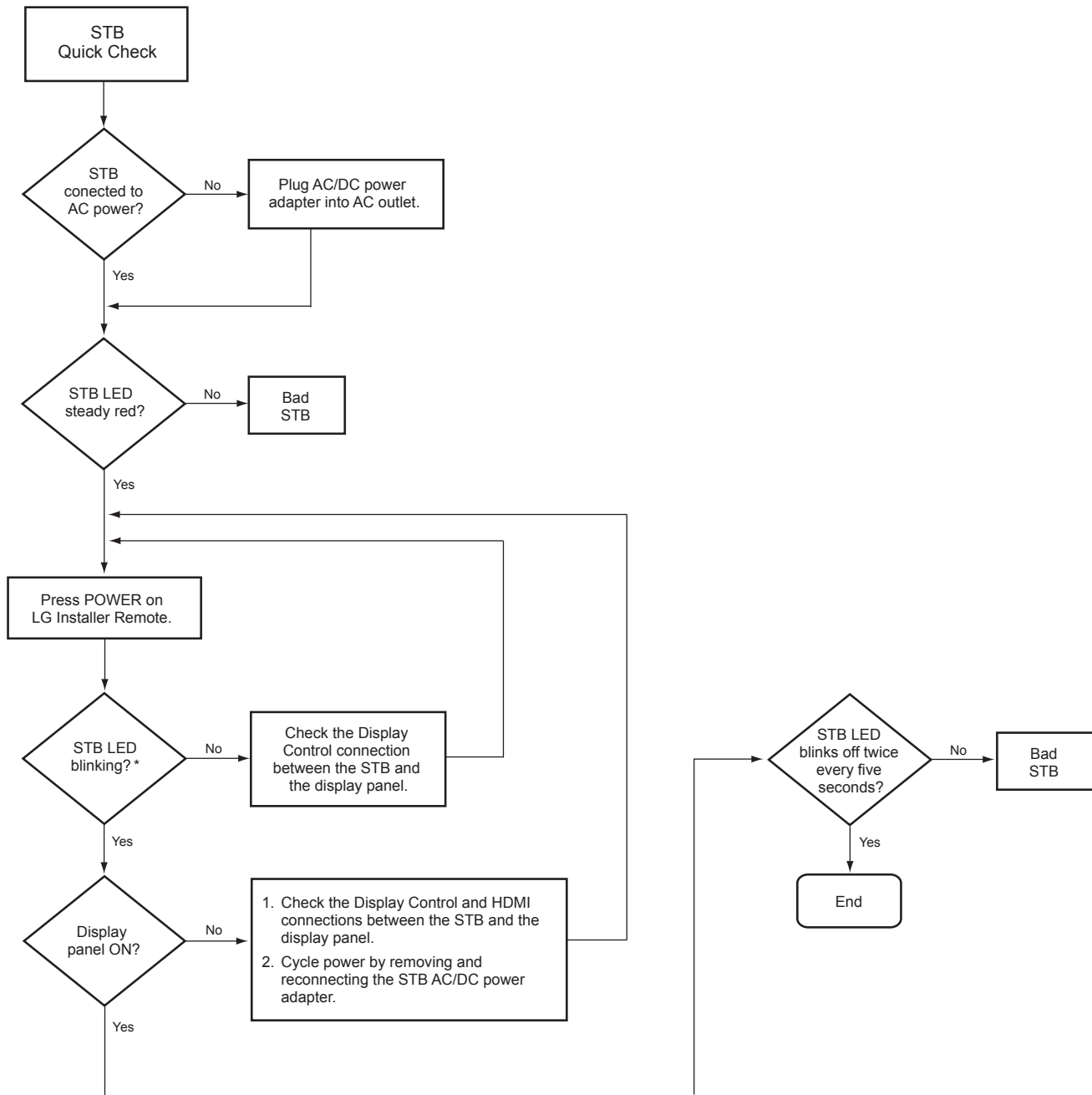

* While the STB is turning ON and sending commands to turn ON the display panel, the LED on the STB's front panel blinks at a constant rate. Once both the STB and the display panel are ON, the STB LED remains lit but blinks off twice in rapid succession every five seconds.

Use this flowchart to determine whether the STB is currently in Commercial Mode.

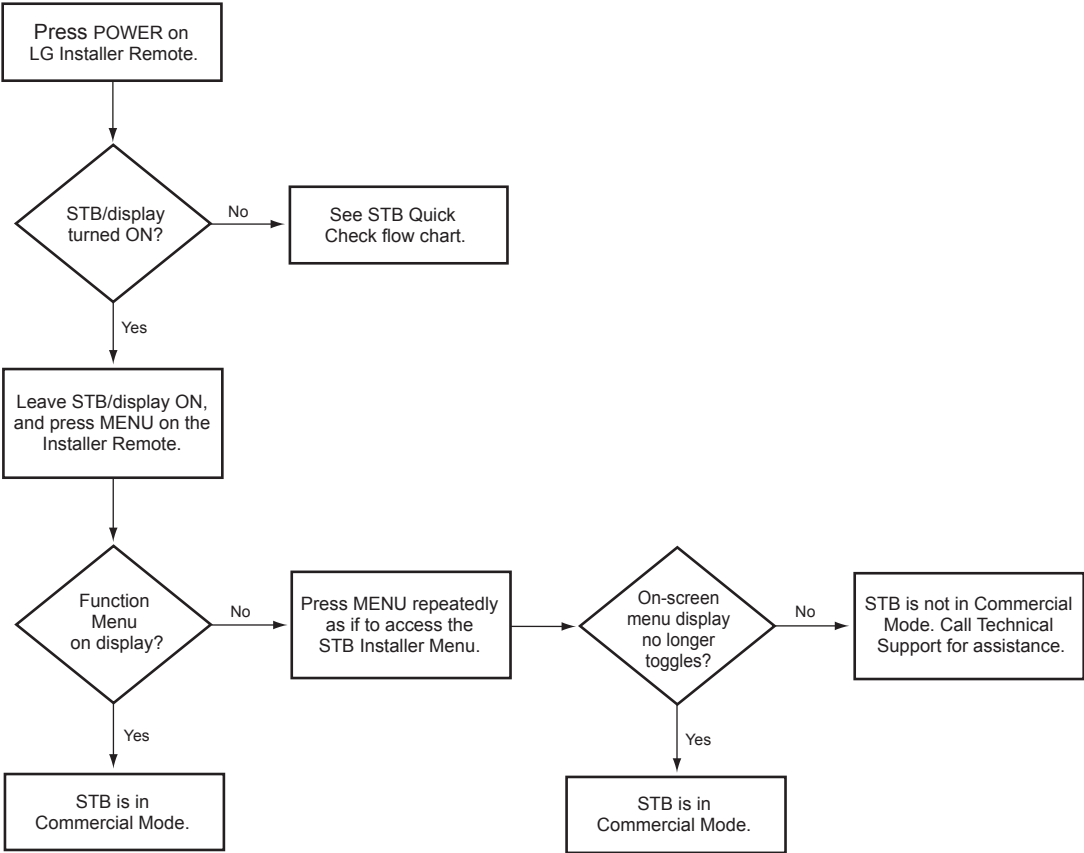

Glossary of Terms

Channel Lineup

Channels set in the STB memory, via Auto Tuning/manual editing.

Cloning

The process of capturing a Master STB Setup and transferring it to a Target STB using a USB memory device.

Commercial Mode

A mode of operation that provides a broad range of commercial STB features based on control (settings) provided by the PTC and/or an MPI control device.

CPU

The STB's Central Processing Unit. Responsible for the presentation of video and audio from content received via the STB's tuner or Aux inputs.

E-Z Installation

Enables STB configuration and software/firmware file downloads to selected STB models from a Pro:Centric server. Managed and administered via the Pro:Centric Admin Client.

EZ-Manager Wizard

Lodging model STB configuration wizard that provides configuration options for Pro:Centric operation as well as an option for using a USB memory device to configure an STB.

FTG Channel Map

Typically refers to a logical channel mapping of physical RF channels. This allows digital channels, like analog channels, to be tuned without requiring the dash key. Also, channels (analog or digital) can be arranged in any order that seems logical for customer tuning/viewing.

FTG Mode

LG commercial STB mode that enables decryption of Pro:Idiom encrypted channels and uses logical channel mapping. LG's proprietary PC software is required for configuration.

Function Menu

Available via Installer Remote "MENU" key. Indicates the STB is not in Pass-through Mode. Restricts menu options to a subset of the STB setup menus, allowing users to retain functional control, while disabling setup options.

Installer Menu

Defines commercial STB functionality based on the parameters set.

LG Free-To-Guest (FTG)

Refers to a particular commercial mode of operation within an LG STB. See also FTG Mode.

Logical Channel Number

A number assigned to either a physical or virtual channel number in a Logical Channel Map.

Major Channel Number

Typically, the RF channel number assigned to a digital video stream.

Master STB

An STB whose Channel Map and Installer Menu and STB setup menu settings have been configured as a Master STB Setup for cloning purposes.

Minor Channel Number

A sub-channel or program number assigned to the content embedded in the digital video stream.

MPI

Multiple Protocol Interface. An MPI port or, for some STB models, an MPI card slot provides external control options for solution providers.

MTI

Multiple Television Interface. SONIFI Solutions, Inc. proprietary protocol used for TV configuration/control via an MTI (typically labeled "DATA") port.

Pass-through Mode

The STB's factory default mode of operation. STBs can be configured for stand-alone use or as Master STBs for cloning purposes, and/or STBs may be controlled externally in this mode.

Physical Channel Number

The major channel number assigned to represent a specific 6 MHz RF band as specified by either the broadcast or CATV channel plan. See CEA (formerly EIA) or NCTA specifications for further information.

Pro:Centric Application

LG content delivery and communication interface that provides interactive entertainment, weather, amenities, etc. information for end users. (Powered by Pro:Centric server.)

Pro:Centric Admin Client

Web editor/content wizard provided for service provider and customer configuration of Pro:Centric application elements.

Pro:Idiom

Zenith proprietary security software that unlocks access to premium content to help assure rapid, broad deployment of HDTV and other high-value digital content.

PTC

Protocol Translator Card. The commercial controller (microprocessor) of the commercial STB.

Target STB

An STB to which a Master STB Setup will be transferred.

STB Setup Menus

Available via Installer Remote "MENU" key in Pass-through Mode only. Menus provide access to setup and functional features of the STB.

USB Memory Device

A USB flash drive or USB storage device, etc. that can be used for STB configuration purposes (typically cloning or FTG Mode via CPU configuration) or for updating STB software.

Virtual Channel Number

An alias (virtual) channel number provided in the data stream, by the broadcaster, of a digital broadcast channel to be displayed by consumer STBs in place of the physical channel number. The major number is the same as the original analog channel number and the minor number is the nth program available in that digital video stream.

Document Revision History / Open Source Software Notice

Document Revision History

Date	Description
July 2014	Revision A: New document
July 2014	Revision B: Additional Pro:Centric IP configuration information

Product documentation is available online at: www.LGolutions.com.

Open Source Software Notice

To obtain the source code under GPL, LGPL, MPL and other open source licenses, that is contained in this product, please visit <http://opensource.lge.com>. In addition to the source code, all referenced license terms, warranty disclaimers and copyright notices are available for download. LG Electronics will also provide open source code to you on CD-ROM for a charge covering the cost of performing such distribution (such as the cost of media, shipping and handling) upon e-mail request to opensource@lge.com. This offer is valid for three (3) years from the date on which you purchased the product.



For Customer Support/Service, please call:

1-888-865-3026

www.LGsolutions.com

Pro:Idiom is a registered trademark of Zenith Electronics LLC. Pro:Centric is a registered trademark of LG Electronics Inc. Smart Share is a trademark of LG Electronics Inc. DLNA Certified is a registered trademark of Digital Living Network Alliance. Intel is a registered trademark of Intel Corporation in the U.S. and/or other countries. Wi-Fi Direct is a registered trademark of Wi-Fi Alliance. *b*-LAN is a trademark of SONIFI Solutions, Inc. All other trademarks or registered trademarks are the property of their respective owners.